

ACCESSORI





LISTINO IN VIGORE DAL 01/02/2021 ANNULLA E SOSTITUISCE TUTTI I PRECEDENTI

NOTA IMPORTANTE!

PER TUTTI GLI ORDINI INVIATI, RICEVERETE LA CONFERMA D'ORDINE VIA EMAIL.

LA STESSA DOVRA ESSERE INOLTRATA CONTROFIRMATA PER ACCETTAZIONE.

PER QUALUNQUE INCONGRUENZA TRA LA CONFERMA D'ORDINE E L'ORDINE (SIA NEI DATI CHE NEI PREZZI) FARA' FEDE LA CONFERMA D'ORDINE.

VI ESORTIAMO QUINDI A VOLER CONTROLLARE ESSA IN OGNI SUA PARTE E DARCI TEMPESTIVA COMUNICAZIONE DI EVENTUALI INCONGRUENZE.

CARATTERISTICHE DEI PRODOTTI: i disegni contenuti nel presente listino sono puramente indicativi, pertanto la nostra azienda si riserva il diritto di apportare modifiche migliorative dei prodotti senza nessun obbligo di preavviso.



La merce viaggia a rischio e pericolo del committente anche se venduta "franco destino".

Gli ordini dovranno essere trasmessi esclusivamente per iscritto a mezzo fax, o on-line, in caso contrario non ci riterremo responsabili della loro errata esecuzione. L'eventuale annullamento di un ordine dovrà essere effettuato per iscritto e/o a mezzo fax o on-line. Non sono incluse nel prezzo di listino eventuali lavori particolari. Ci si riserva l'annullamento di un ordine per causa di forza maggiore.

L'uso improprio della merce fornita e/o il suo utilizzo in particolari condizioni climatiche ed ambientali non comporta alcuna responsabilità riconducibile al venditore.

L'esecuzione parziale e ritardata dell'ordine non dà diritto ad annullamenti di qualsiasi genere, né ad eventuali rivalse.

La merce lasciata in riparazione o in sostituzione e non ritirata entro i 30 giorni successivi alla data prevista per la consegna potrà essere avviata al macero.

Gli eventuali reclami dovranno essere motivati e proposti, pena la decadenza, entro 5 giorni dall'arrivo della merce esclusivamente per mezzo di lettera raccomandata. Trascorso tale termine la merce si intende definitivamente accettata dall'acquirente. Si intende ugualmente accettata la merce che l'acquirente abbia utilizzato in tutto o in parte. I reclami della merce, se fondati, danno diritto soltanto alla sostituzione o alla resa della stessa, senza alcun indennizzo.

I prezzi del presente listino sono al netto dell' I.V.A. e potranno essere variati senza nessun preavviso.

Il ritardo del pagamento, rispetto i termini concordati, comporta l'obbligo per l'acquirente di corrispondere l'interesse bancario secondo i tassi correnti.

Per qualsiasi controversia si farà riferimento all' Autorità Giudiziaria competente nel territorio del venditore.

Eventuali resi dovranno essere autorizzati dall'azienda o dal personale autorizzato.

I resi verranno accettati solo se accompagnati dal Documento di Trasporto e relative descrizioni.

L' Azienda si riserva di perfezionare le nuove forniture solo quando siano stati effettuati i pagamenti dovuti.

La merce rimane proprietà dell'azienda fino al completo pagamento.



GENERAL CONDITIONS OF SALE

The goods travel at the risk and peril of the customer even if sold "free at destination".

Orders must be sent in writing only by fax, or online, otherwise we will not be responsible for their incorrect execution. Any cancellation of an order must be made in writing and / or by fax or online. Any special works are not included in the list price. We reserve the right to cancel an order due to force majeure.

The improper use of the supplied goods and / or its use in particular climatic and environmental conditions does not imply any responsibility attributable to the seller.

The partial and delayed execution of the order does not give the right to cancellations of any kind, nor to any recourse.

The goods left in repair or in replacement and not withdrawn within 30 days after the scheduled delivery date can be sent for recycling.

Any complaints must be motivated and proposed, under penalty of forfeiture, within 5 days of the arrival of the goods exclusively by registered letter. After this deadline the goods are considered definitively accepted by the buyer. The goods that the buyer has used in whole or in part are also considered accepted. Claims of the goods, if founded, only entitle them to be replaced or returned, without compensation.

The prices in this price list are net of I.V.A. and may be changed without prior notice.

The delay in payment, with respect to the agreed terms, involves the obligation for the buyer to pay the bank interest according to current rates.

For any dispute, reference will be made to the competent judicial authority in the territory of the seller.

Any returns must be authorized by the company or authorized personnel.
Returns will be accepted only if accompanied by the Transport Document and related descriptions.
The Company reserves the right to finalize new supplies only when payments have been made.
The goods remain the property of the company until full payment.



CONDITIONS GENERALES DE VENTE

La marchandise voyage au risque et au danger de l'acheteur, même si vendue "franco destination".

Les commandes doivent être transmises uniquement par écrit et par fax, autrement nous ne serons pas responsables de leur mauvaise exécution. Toute annulation d'une commande doit être faite par écrit et/ou par télécopieur. Ne sont pas inclus dans la liste des prix les travaux de maçonnerie, d'électricité, de soudure et plaques spéciales. Nous nous réservons l'annulation d'une commande en raison de force majeure.

Une utilisation incorrecte de la marchandise livrée et / ou son utilisation dans des conditions climatiques particulières et environnementales ne comporte pas aucune responsabilité imputable au vendeur.

L'exécution partielle et retardée de la commande ne donne pas droit à des annulations de toute nature, ni à des représailles.

La marchandise laissée en réparation et pas retirée dans les 30 jours suivants la date prévue pour la livraison pourra être initiée à la macération.

Toutes les plaintes doivent être motivées et proposées, peine de déchéance, dans les 5 jours suivants l'arrivée de la marchandise exclusivement au moyen d'une lettre recommandée. Après ce temps, la marchandise est définitivement acceptée par l'acheteur. On entend aussi acceptés les marchandises que l'acheteur a utilisés, en tout ou en partie. Les plaintes des marchandises, si fondées, donnent le droit uniquement au remplacement ou à la remise de la même, sans aucune compensation.

Les prix mentionnés dans cette liste de prix sont hors TVA et sont sujets à changement sans préavis.

Le retard du paiement, par rapport aux modalités convenues, implique l'obligation de l'acheteur de payer les intérêts de la banque selon les tarifs en vigueur.

Tout litige sera soumis à l'autorité judiciaire compétente sur le territoire de la vente.

Les retours doivent être autorisés par la Société ou par le personnel autorisé.
Les retours ne seront acceptés que se ils sont accompagnés par le document de transport et les descriptions.
La Société se réserve de perfectionner les nouveaux approvisionnements seulement quand ils ont été effectués les paiements dus.
Les marchandises restent la propriété de la société jusqu'au complet paiement.

INDICE / INDEX / INDEX

TENDE A CADUTA / DROP AWNINGS / STORES EXTERIEUR

■ TNR - TCN - TM	6
■ TMS	14
■ TMS SILVER	18
■ TB FIRENZE	22
■ P-GOLD	24
■ TORTIGLIONE	28
■ VENEZIA	30
■ TCL ALFA - BETA	36
■ TCL GAMMA	40
■ TCL OMEGA	44

TENDE PER ATTICO / ATTIC AWNINGS / STORES VERANDAS

■ TMT	48
■ TMT PLUS	52
■ GARDEN	56
■ NEW GARDEN	60
■ RAFFAELLO	64

TENDE A BRACCI / FOLDING ARM AWNINGS / STORES A BRAS

■ BQC LUX	68
■ BQC COMPACT	74
■ EUROPE SHADOW	80
■ KENIA	84
■ BQ 40 PLUS	90
■ SPAGNA	94
■ OMBRA	98
■ KIRO 40 B/Q	102
■ LIBERTY P/S-ECLISSE	106
■ EUROPA 4000	110
■ VARESE	112
■ STAR BOX	116
■ VERONA	120

CAPPOTTINE / BASKET AWNINGS / STORES CORBEILLE

■ CAPPOTTINE	122
■ ASIA	128
■ ECO TUNNEL	130

VETRATE/ / GLASS WINDOWS / FENÊTRES EN VERRE

■ SCREENS	132
■ VETRATA SCORREVOLE	136
■ SCREENS GLASS	140

ACCESSORI ED ELETTRONICA / ACCESSORIES AND ELECTRONICS / ACCESSOIRES ET ELECTRONIQUE

■ CALOTTE	144
■ ASTE DI MANOVRA	145
■ TUBI AVVOLGITORI	146
■ MOLLE	146
■ BRACCI	148
■ MOTORI	152
■ ELETTRONICA	154
■ TELECOMANDI	157
■ MODULO ORDINE	159

SIMBOLOGIA / SIMBOLOGY / SYMBOLOGIE

Cf = Confezione / Packaging / Confection

Pz = Pezzo / piece / pièce

Cp = coppia / pair/ paire

Ml = Metro lineare / linear meter / mètre linéaire

Bb = Bobina / bobin / bobine



Argano
Gearbox
Treuil



Kit Bracci incrociati
Crossing arms kit
Kit bras croisés



Tubo Ø 60
Tube Ø 60
Tube Ø 60



Molla
Spring
Ressorts



Motore
Motors
Moteurs



Tubo Ø 70
Tube Ø 70
Tube Ø 70



Tettino
Canopy
Auvent



Corda
Rope
Corde



Tubo Ø 80
Tube Ø 80
Tube Ø 80

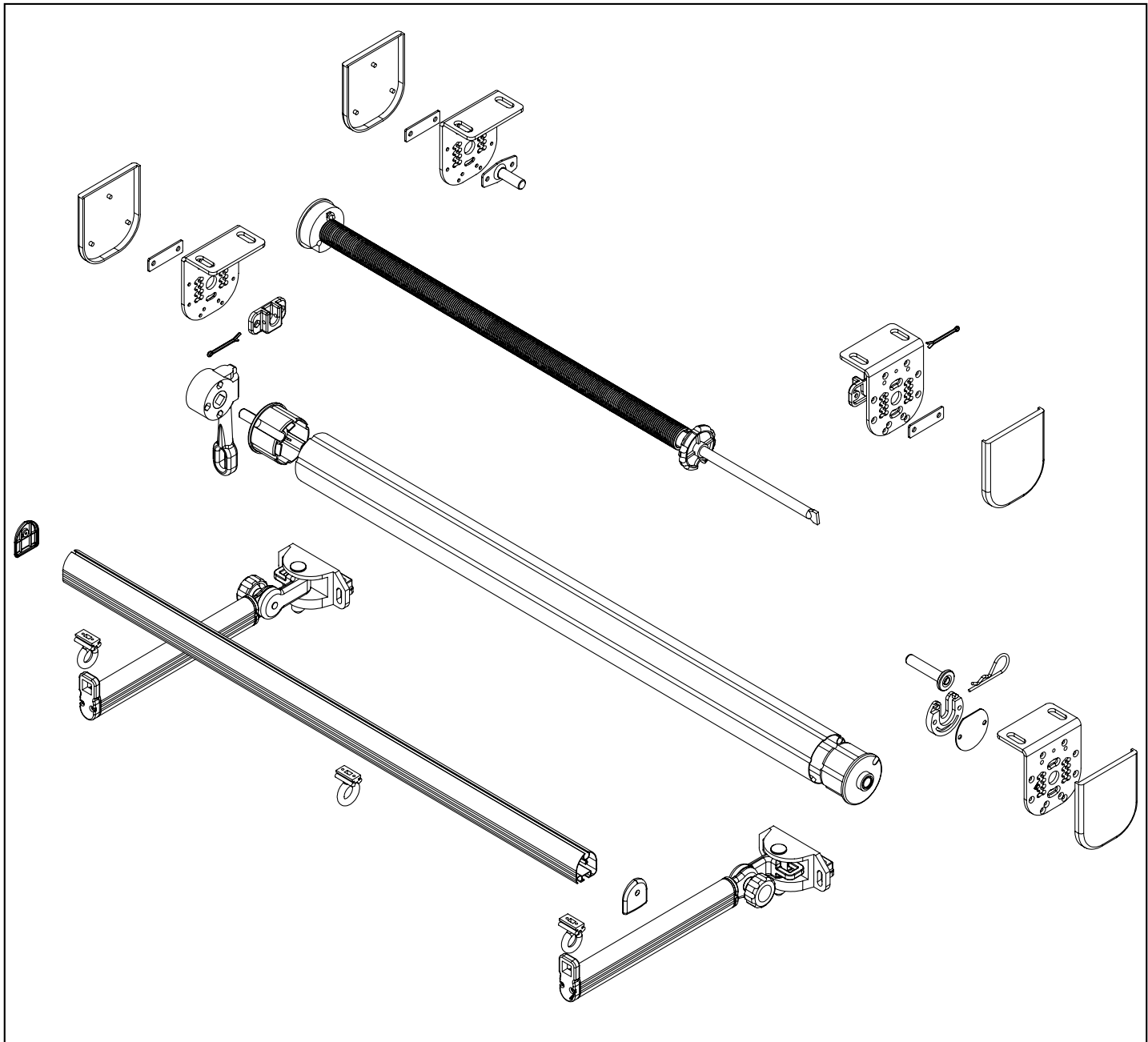

Colori di serie / Standard color / Couleurs standard



Ral Bianco 9010	Ral Verde 6005	Ral Avorio 1013	Ral Marrone 8017	Ral Grigio 7035
-----------------------	----------------------	-----------------------	------------------------	-----------------------

Ral Antracite 9005	Ral Bronzo	Ral Nero opaco 9005	Ral Tecno brown 8028
--------------------------	---------------	---------------------------	----------------------------

Altri colori / Another colors / Autres couleurs +20%

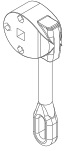
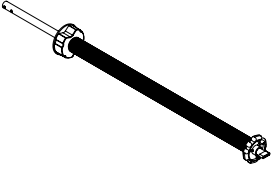
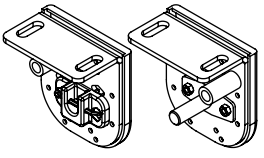
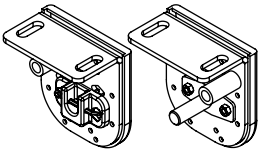
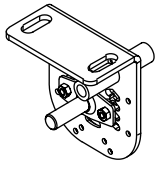
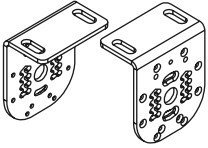
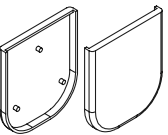
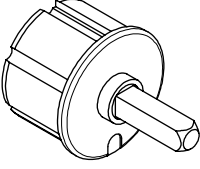
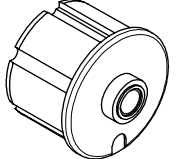
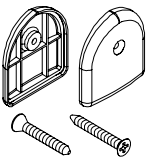
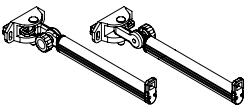

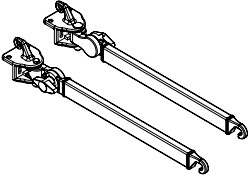
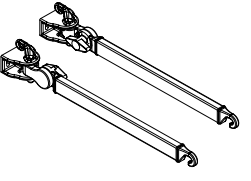
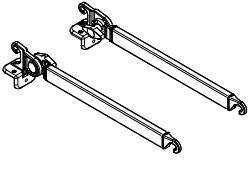
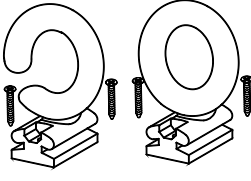
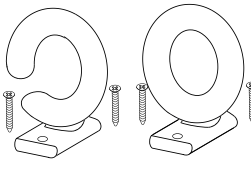
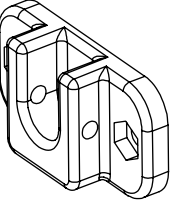
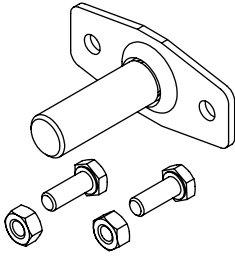
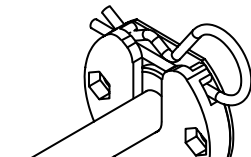

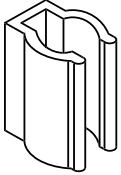
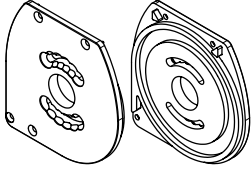
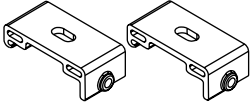
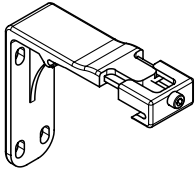
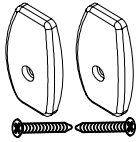
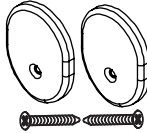
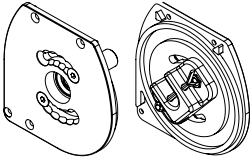
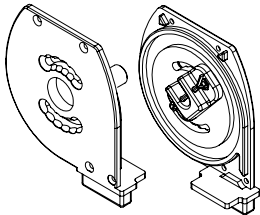
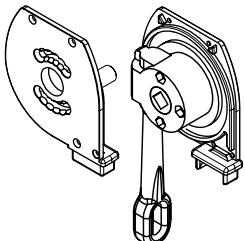
Disegno Figure Dessign	Descrizione Description Description	Codice Article Code Code Article	U.M. Unit	Prezzo unitario Unit price Prix unitaire	Conf. std. Std. pack Cf. std
	Arganello riduttore Awning gearbox Treuil	ARG 7:1A ARG3,5:1A	Pz		25
	Molla assemblata ø 60 Spring assembled ø 60 Ressort assemblé ø.60	Cm 35 MOLLA35 Cm 50 MOLLA50 Cm 70 MOLLA70 Cm 90 MOLLA90 Cm 120 MOLLA120 Cm 140 MOLLA140	Pz		10
	Staffe tnr p/s con cuffie Brackets tnr wall/ceiling with cover Supports tnr mur/plafond avec bouchons	TNRS0A003	Cp		50
	Staffe tnr p/s senza cuffie Brackets tnr wall/ceiling without cover Supports tnr mur/plafond sans bouchons	TNRS0A004			
	Staffa tnr p/s accoppiata Bracket tnr wall/ceiling compound Support tnr mur/plafond uni	TNRS0A005	Pz		50
	Staffa tnr p/s nuda Bracket tnr wall/ceiling simple Support tnr mur/plafond simple	TNRS0A006	Cp		50
	Cuffie per staffe tnr Bushing for pivot arm tnr Bouchons pour supports tnr	C0A002	Cp		100
	Tappo ø 60 perno quadro 13x40 Plug ø 60 with square pin 13x40 Embout ø axe carré 13x40	TAPPQ60-13x40	Pz		120
	Tappo ø 60 con foro ø 14 Plug ø 60 with hole ø 14 Embout ø 60 avec trou ø 14	TAPF60	Pz		150
	Tappo terminale tnr in nylon con viti Caps for terminal profile tnr with screw Bouchons barre de charge tnr en nylon avec vis	Zinc. TNRT0A006 Inox. TNRT0A02	Cp		50
	Braccetti tnr Arms tnr Bras tnr	Ring. TNR0A017 Muro TNR0A018	Cp		15

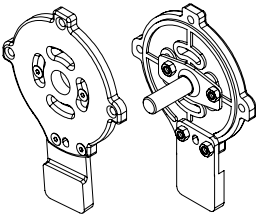
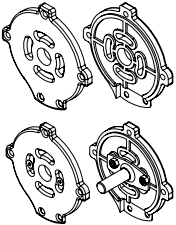
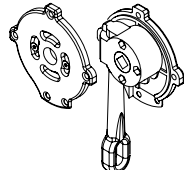
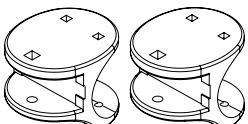
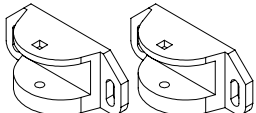
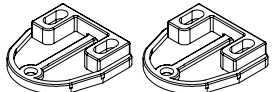
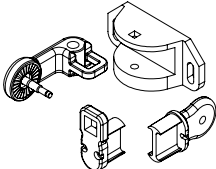
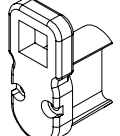
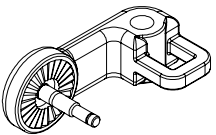
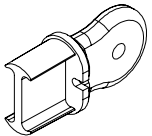
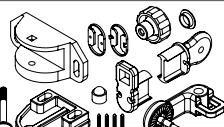

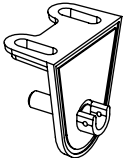
Disegno Figure Dessign	Descrizione Description Description		Codice Article Code Code Article	U.M. Unit	Prezzo unitario Unit price Prix unitaire	Conf. std. Std. pack Cf. std
	Braccetti snodati con gancio aperto Articulated arms with open hook Bras articulés avec crochet ouvert\	Ringhiera	NAPO-047	CP		25
	Braccetti snodati con gancio aperto Articulated arms with open hook Bras articulés avec crochet ouvert\	Muro	NAPO-046	CP		25
	Braccetto fissi con gancio aperto Arms fixed with open hook Bras fixes avec crochet	Ring. Muro	NAPO 030 NAPO-035	Cp		250
	Occhiolo terminale tnr/tm in Nylon con grani zincati/inox Eyelit open open tnr/tm nylon With zinc/ steel screws Goulotte barre de charge tnr/tm en nylon avec vis	Zinc. aperto Zinc. chiuso Inox ape Inox chiuso	TMOCCNYLONA TMOCCNYLON1A TMOCCNYLON2A TMOCCNYLON3A	Pz		100 50 100 50
	Occhiolo terminale tnr/tm in alluminio con grani zincati/inox Eyelit open open tnr/tm alluminio With zinc/ steel screws Goulotte barre de charge tnr/tm en aluminium avec vis	Zinc. aperto Zinc. chiuso Inox ape Inox chiuso	TMOCCALLA TMOCCALL1A TMOCCALL2A TMOCCALL3A	Pz		100 50 100 50
	Piastrina omega in nylon Nylon omega Plaque oméga en nylon		TNRM-045	Pz		100
	PIASTRINA CON PERNO PLATE WITH PIN PLAQUE AVEC AXE Senza bulloni e dadi Without bolts and nuts Sans boulons et écrous Con bulloni M6x16 e dadi M6 With bolts M6x16 and nuts M6 Avec boulons M6x16 et écrous M6	14x40 14x75 14x40 14x75	PCP00001 PCP00002 PCP00003 PCP00004	Pz		100
	Piastrina in nylon con perno estraibile Plate nylon with removable pin Plaque en nylon avec axe extraible		PES0005	Pz		100

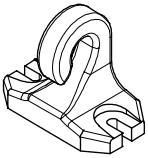
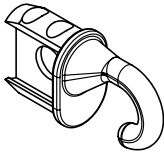
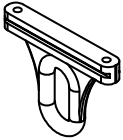
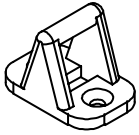
Disegno Figure Design	Descrizione Description Description	Codice Article Code Code Article	U.M. Unit	Prezzo unitario Unit price Prix unitaire	Conf. std. Std. pack Cf. std
	Supporto asta Bushing for pivot arm tnr/tm	Mm 20. TMSUP.ASTA1A	Pz		100
	Supporto manivella Support manivelle	Mm 14 TMSUP.ASTA2A			
	Tappi cassonetto tcn Caps for box tcn Bouchons coffre tcn	TCN0A0002	Cp		100
	Supporti soffitto cassonetto tcn Support box for ceiling tcn Supports plafond pour coffre tcn	TCN0A0004	Cp		100
	Supporto parete cassonetto tcn Support box for wall tcn Support mur pour coffre tcn	TCN0A0005	Pz		100
	Tappi terminale tcn con viti Plug for terminal profile tcn with screws Bouchons barre de charge tcn	TCN0A0003	Pz		100
	Tappi terminale tcn con viti Plug for terminal profile tcn with screws Bouchons barre de charge tcn	TNRM-055	Pz		100
	Tappi cassonetto tcn a molla Caps box tcn spring Bouchons coffre tcn avec ressort	TCN0A0006	Cp		50
TAPPI CASSONETTO TCN A MOLLA / CAPS BOX TCN SPRING / BOUCHONS COFFRE TCN AVEC RESSORT					
	Con innesto guida tmt With attachment tmt	TCN0A007	Cp		50
	Avec attache guide tmt Con innesto guida tms With attachment tms Avec attache guide tms	TCN0A008			
TAPPI CASSONETTO TCN AD ARGANELLO / CAPS BOX TCN AWNING / BOUCHONS COFFRE TCN AVEC TREUIL					
	Con innesto guida tmt With attachment tmt	TCN0A009	Cp		50
	Avec attache guide tmt Con innesto guida tms With attachment tms Avec attache guide tms	TCN0A010			

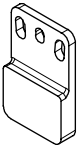
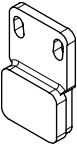
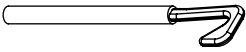
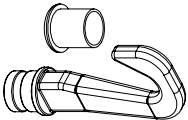
Disegno Figure Dessign	Descrizione Description Description	Codice Article Code Code Article	U.M. Unit	Prezzo unitario Unit price Prix unitaire	Conf. std. Std. pack Cf. std
	TAPPI CASSONETTO TM/TNR / CAPS BOX TM/TNR / CAPS BOX TM/TNR Con innesto guida tmt With attachment tmt Avec attache guide tmt Con innesto guida tms With attachment tms Avec attache guide tms	TNR0A014 TNR0A029	Cp		50
	Tappi cassonetto tm/tnr nudi Caps for box tm/tnr simple Bouchons coffre tm/tnr simples Con omega e perno maschio Caps for box tm/tnr omega and pin Avec omega et axe male	TNR0A024 TNR0A022	Cp		50
	Tappi cass. Tm/tnr con argano e omega in nylon Caps for box tm/tnr with and omega in nylon Bouchons coffre tnr/tm avec treuil et omega en nylon	TNR0A023	Cp		50
	Supporto a ringhiera tonda Round railing support Support de garde-corps rond	Ø 50 TNRM047 Ø 60 TNRM054	Cp		50
	Supporto a muro per braccetto tnr Support for arms for wall railing tnr Support mur pour bras tnr	TNRT0A007	Cp		50
	Piastrine a ringhiera per braccetto tnr Plates for railing of arm tnr allum. Plaquettes balustrade pour bras tnr	TNRT0A008	Cp		50
	Kit fusioni braccetto tnr Kit mergers for arm tnr Kit bras tnr	TNRT0A009	Pz		50
	Puntale braccetto tnr Tip of arm tnr allum. Pointe bras tnr	TNRT0A013	Pz		100
	Snodo braccetto tnr Joint for arm tnr allum. Articulation bras tnr	TNRT0A015	Pz		100
	Corona braccetto tnr Crown arm tnr allum. Couronne bras tnr	TNRT0A017	Pz		100
	Kit braccetto tnr completo di profili Kit arm full profile tnr allum. Kit bras complet de profils	TNRT0A019	Cp		50

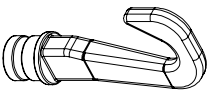
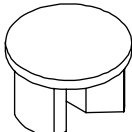
Disegno Figure Design	Descrizione Description Description	Codice Article Code Code Article	U.M. Unit	Prezzo unitario Unit price Prix unitaire	Conf. std. Std. pack Cf. std
	Guarnizioni braccetto tnr Seals arms tnr Joint bras tnr	TNR0A010	Cp		100
	Molla per braccetto tnr Spring for arm tnr Ressort pour bras tnr	MOLLA-BR	Pz		100
	Boccola snodo braccetto tnr/tm Bushing for pivot arm tnr/tm Bague bras tnr/tm	BQC0D002	Pz		100
	Manopola con tappo Knob with bush brass with cap Bouton avec bouchon Tappo manopola Control knob cap Bouchon	MAN0D001 MAN0D002	Pz		100
	Clips braccetto Clips arm Clips bras	CLIPS-BR	Pz		100
	Supporti cassonetto tm/tnr Support for box tnr/tm Supports coffre tnr/tm Completi di bulloni e dado Support box tnr/tm with bolt and nut Complets de boulons et écrous	TNR0A015 TNR0A032	Cp		25
	Supporti tm p/s completi Kit support tm wall/ceiling Supports tm mur/plafond Complets	TM0A001	Cp		25
	Supporto femmina tm p/s Support female tm wall/ceiling Support tm mur/plafond	TM0A003	Pz		25
	Supporto maschio tm p/s Support male tm wall/ceiling Support tm mur/plafond Avec axe	TM0A004	Pz		25
	Supporto tm p/s accoppiata Coupled support tm wall/ceiling Support tm mur/plafond uni	TM0A002	Pz		25
	Staffa universale tm con asole Universal bracket tm with slots allum. Support univ. Tm avec trous	TM0A015	Pz		25

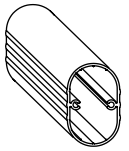
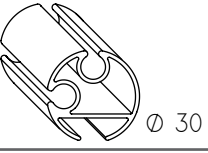
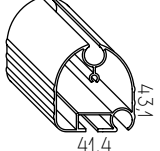
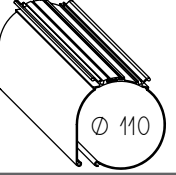
Disegno Figure Dessign	Descrizione Description Description		Codice Article Code Code Article	U.M. Unit	Prezzo unitario Unit price Prix unitaire	Conf. std. Std. pack Cf. std
	Attacco a terra pvc Ground attack open pvc Crochet au sol en pvc		TNR0A036	Pz		100
	Puntale aperto in alluminio Open toe at aluminium Crochet en aluminium		TNRT0A028	Pz		100
	Occhiolo chiuso in nylon Eyelet closed nylon Crochet en nylon		TNR0A027	Pz		100
	Attacco a terra chiuso in pvc Coupler to the ground pvc Attaque au sol fermé en pvc		TMERRA	Pz		100
	Coppiglia dritta 4 x 50 Cotter pin 4 x 50 Goupille 8 x50		COPPIGLIA	Pz		100
	Innesto guida tmt With attachment tmt Insert pour guide tmt		TNR0A020	Cp		100
	Innesto guida tms With attachment tms Insert pour guide tms		TMS0A021	Cp		100
	Asta per tm/tnr Crank handle for tm/tnr Manivelle pour tm/tnr	Cm 140	TM0A006	Pz		25
	Kit asta per tenda a molla completo Kit crank handle for awning spring Kit manivelle pour store avec ressort complet		KIT.ASTA	Pz		100
	Tappo per asta ø 20 Cap for crank handle ø 20 Bouchon pour manivelle ø 20		TAP.ASTA	Pz		100
	Gancio per asta ø 20 Hook for crank handle ø 20 Crochet pour manivelle ø 20		GAN.ASTA	Pz		100
	Tappo terminale tm in nylon Plug for terminal profisle tm Bouchon barre de charge tm en nylon	Ø 30	TAPTM30A	Pz		100
		Ø 35	TAPTM35A			

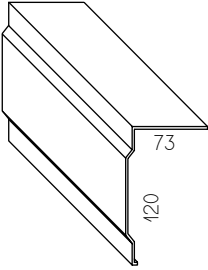
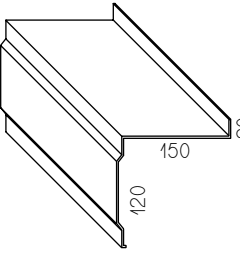
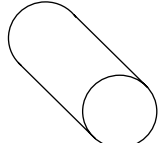
Disegno Figure Design	Descrizione Description Description		Codice Article Code Code Article	U.M. Unit	Prezzo unitario Unit price Prix unitaire	Conf. std. Std. pack Cf. std
	Profilo per braccetto tnr Profile for arm tnr Profil pour bras tnr	535gr/ml	Cm 560 TNR5,6	Pz		10
	Terminale tm ø 30 3 gole Terminal profile tm ø 30 3 holes Barre de charge tm ø 30 3 trous	632gr/ml	Cm 300 Cm 400 Cm 700	TM3A005 TM4A005 TM7A005	Pz	10
	Terminale tnr 852 Terminal profile tnr 852 Barre de charge tnr 852	624gr/ml	Cm 300 Cm 400 Cm 700	TNR3A001 TNR4A001 TNR7A001	Pz	10
	Cassonetto di protezione tcn Box of protection tcn Coffre tcn	1884gr/ml	Cm 300 Cm 700	TCNCASS3A TCNCASS7A	Pz	10
	Terminale tcn Terminal profile tcn Barre de charge tcn	582gr/ml	Cm 300 Cm 700	TCNTER3A TCNTER7A	Pz	10
	Terminale tcn Terminal profile tcn Barre de charge tcn	624gr/ml	Cm 300 Cm 700	TCNTER3A TCNTER7A	Pz	10
	Tettino di protezione Tm/tnr/tmt a soffitto Canopy of protection Tm/tnr/tmt for celing Auvent plafond pour tm/tnr/tmt	1134gr/ml	Cm 300 Cm 400 Cm 700	TM3A018 TM4A018 TM7A018	Pz	10
	Tettino di protezione Tm/tnr/tmt a parete Canopy of protection Tm/tnr/tmt for wall Auvent mur pour tm/tnr/tmt	1675gr/ml	Cm 400 Cm 500 Cm 600 Cm 700	TMT4A015 TMT5A015 TMT6A015 TMT7A015	Pz	10
	Profilo Ø 20 per asta di manovra Profile Ø 20 for maneuver rod Profil Ø 20 pour tige de manouvre		Cm 300 Cm 700	TM3A014 TM7A014	Pz	10

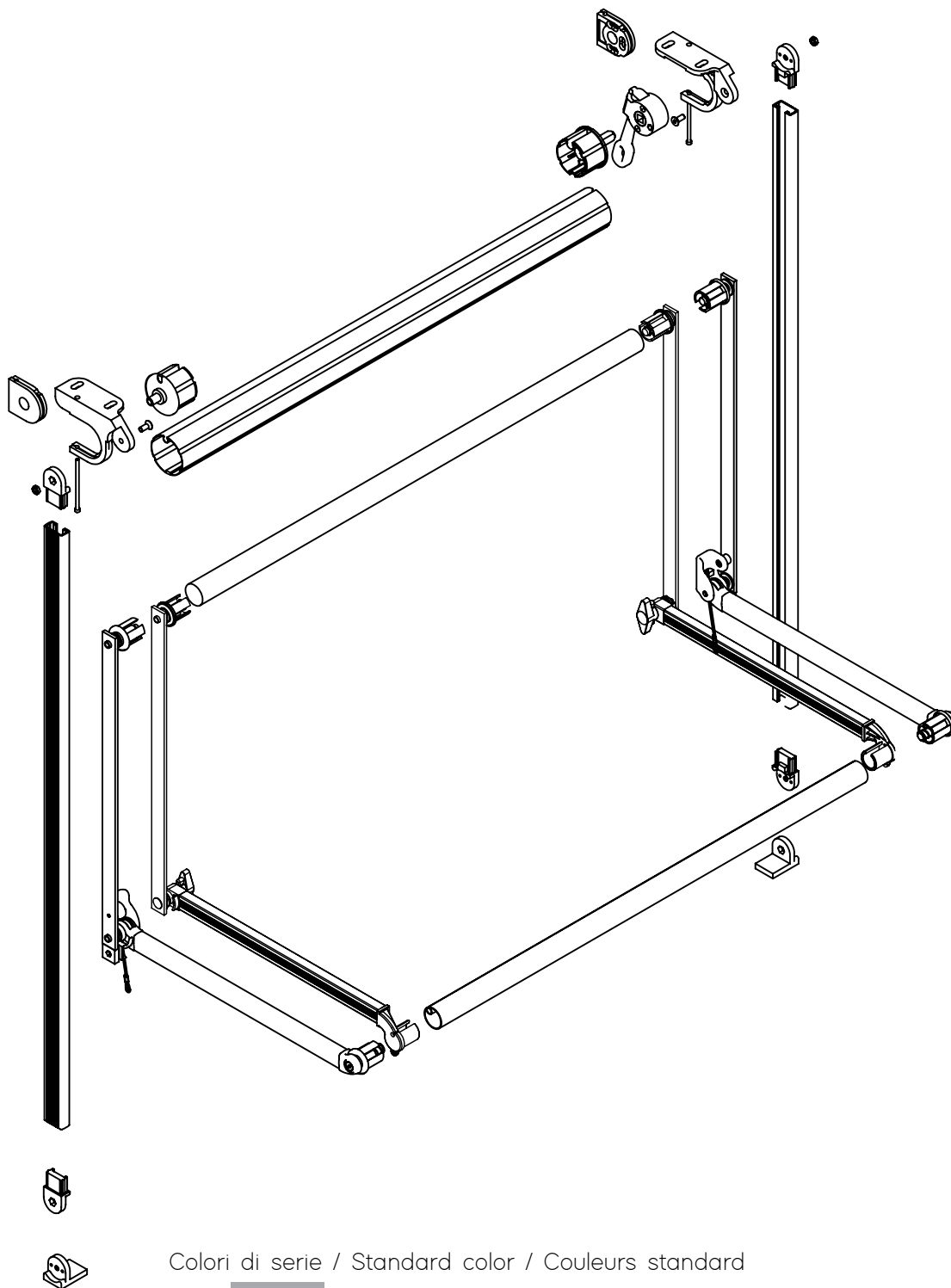

Colori di serie / Standard color / Couleurs standard



Ral
Bianco
9010



Ral
Avorio
1013

Ral
Grigio
7035

Ral
Bronzo

Ral
Oro

Altri colori / Another colors / Autres couleurs +20%

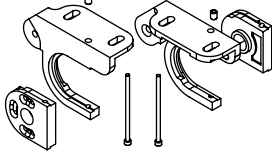
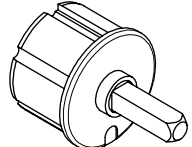
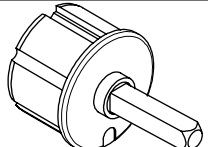
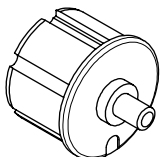
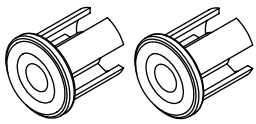
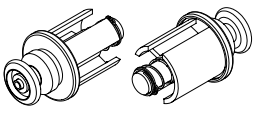
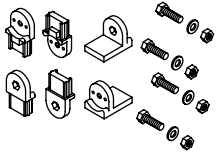
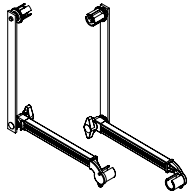
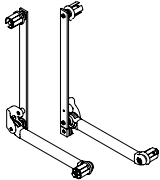
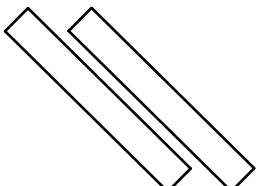
Disegno Figure Design	Descrizione Description Description	Codice Article Code Code Article	U.M. Unit	Prezzo unitario Unit price Prix unitaire	Conf. std. Std. pack Cf. std
	Arganello riduttore 4,7:1 gambo corto TMS Awning gearbox 4,7:1 Treuril 4,7:1	ARG-4,7:1A	Pz		25
	Arganello riduttore 7:1 TMS BR Awning gearbox 7:1 Treuril 7:1	ARG7:1A			
	Supporti in alluminio con boccole Ceiling supports at allum. Kit with bushings Supports plafond en aluminium avec bagues	TMS0A003	Cp		20
	Tappo ø 60 con perno quadro 13x25 TMS Plug with square pin 13x25 ø 60 Embout ø 60 avec axe carré 13x25	TAPPQ60-13X25	Pz		80
	Tappo ø 60 con perno quadro 13x40 TMS BR Plug with square pin 13x40 ø 60 Embout ø 60 avec axe carré 13x40	TAPPQ60-13X40	Pz		80
	Tappo ø 60 con perno tondo 14x20 Plug with round pin 14x20 ø 60 Embout ø 60 avec axe rond 14x20	TAPPT60	Pz		100
	Calotta ø 40 frangivento tms Caps d.40 For windbreak tms Embout ø 40 brise-vent tms	TAPS40A	Pz		25
	Calotta scorrevole ø 40 tms Caps sliding ø 40 tms Embout coulissant ø 40 tms	TAPSCO40A	Cp		25
	Piedini e attacchi per guida Legs and attacks for guide Pieds et attaches pour guide	TMS0A002	Cf		25
	Braccetti tms Awning arms tms Bras tms	TMS0A001	Cp		6
	Braccetti tms a molla Awning arms with spring tms Bras tms avec ressort	TMS0A005	Cp		6
	Linguetta per guida tms Tap for guide tms Languette pour guide	TMS0A020	Cp		6

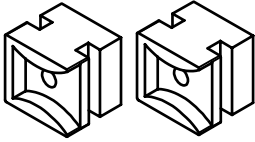
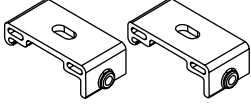
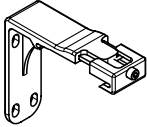
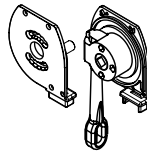
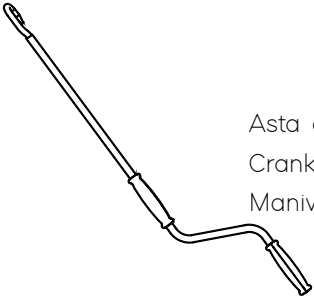
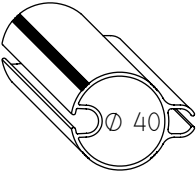
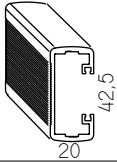
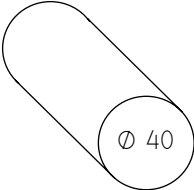
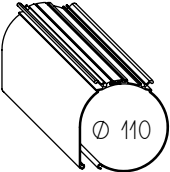
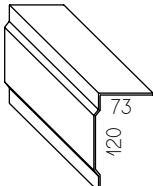
Disegno Figure Dessign	Descrizione Description Description	Codice Article Code Code Article	U.M. Unit	Prezzo unitario Unit price Prix unitaire	Conf. std. Std. pack Cf. std
	Scorrevole per guida tms Sliding for guide tms Coulisse pour guide tms Scorrevole per guida tms a molla Sliding for guide a spring tms Coulisse pour guide tms avec ressort	TMSSCORA TMSSCO-1A	Cp		50
	Supporti soffitto cassonetto Support box for ceiling tcn Supports plafond pour coffre tcn	TCN0A0004	Pz		100
	Supporto parete cassonetto Support box for wall Support mur pour coffre tcn	TCN0A0005	Pz		100
	Tappi cassonetto ad arganello 4,7/1 Gambo lungo 4.7: 1 gear box caps with long stem 4.7: 1 capuchons de boîte de vitesses à longue tige	TCN0A010	Cp		50
	Asta di manovra verniciata Crank handle Manivelle laquée	Cm 35 Cm 50 Cm 70 Cm 90 Cm 120 Cm 140 Cm 250 Cm 300	AST0A100 AST0A120 AST0A150 AST0A180 AST0A200 AST0A220 AST0A250 AST0A300	Pz	10
	Terminale tms d.40 Terminal profile tms d.40 Barre de charge tms ø 40	Cm 400 Cm 500 Cm 600 Cm 700	TMS4A010 TMS5A010 TMS6A010 TMS7A010	Pz	10
	Guida tms Guide allum. Tms Guide tms	Cm 700	TMSA700	Pz	10
	Frangivento tms ø 40 Windbreak tms ø 40 Brise-vent tms ø 40	Cm 400 Cm 500 Cm 600 Cm 700	TMS4A003 TMS5A003 TMS6A003 TMS7A003	Pz	10
	Cassonetto di protezione tms Box of protection tms Coffre tms	Cm 300 Cm 700	TCNCASS3A TCNCASS7A	Pz	10
	Tettino di protezione a soffitto Canopy of protection for celing Auvent plafond pour	Cm 300 Cm 400 Cm 700	TM3A018 TM4A018 TM7A018	Pz	10

Note

A large rectangular area with horizontal dotted lines, intended for writing notes.



60

70

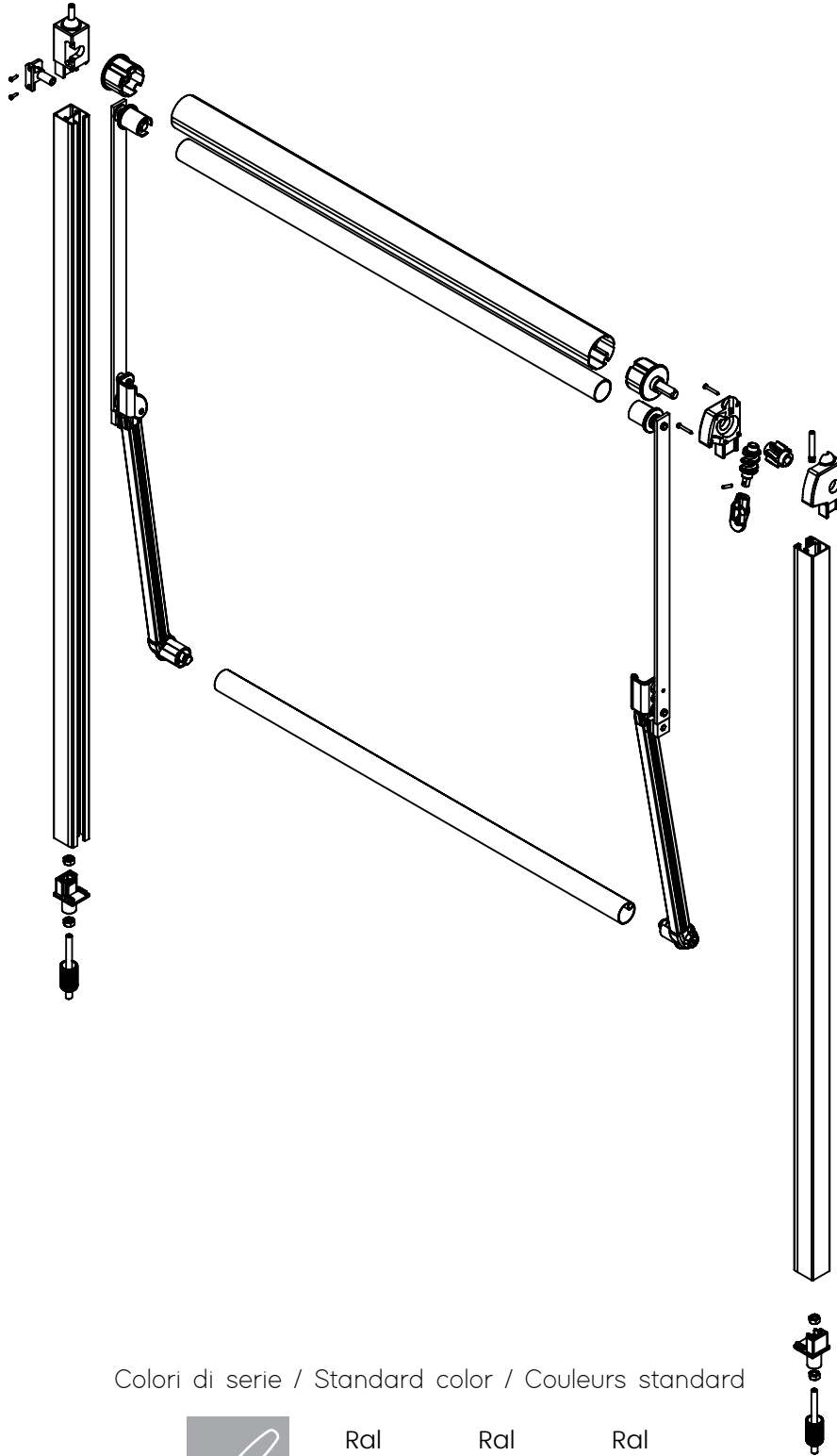

Colori di serie / Standard color / Couleurs standard



Ral
Bianco
9010

Ral
Avorio
1013

Ral
Grigio
7035

Ral
Bronzo

Ral
Oro

Altri colori / Another colors / Autres couleurs +20%

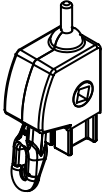
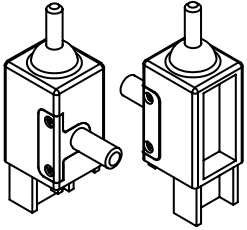
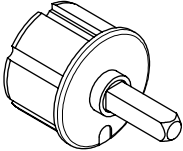
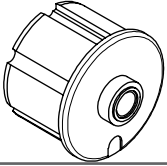
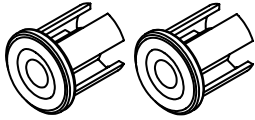
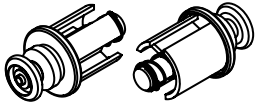
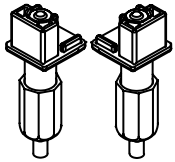
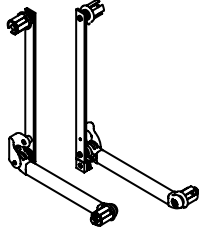
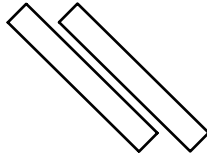
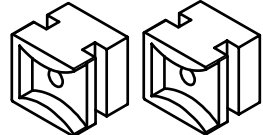
Disegno Figure Design	Descrizione Description Description	Codice Article Code Code Article	U.M. Unit	Prezzo unitario Unit price Prix unitaire	Conf. std. Std. pack Cf. std
	Arganello tms silver Awning tms silver Treuil tms silver	SILVR-015	Pz		10
	Innesto superiore guida dx Right upholstery engagement Guide supérieur à droit Innesto superiore guida sx Left upholstery engagement Guide supérieur à gauche	SLVR-013 SLVR-018	Pz		10
	Tappo ø 60 con perno quadro 13x40 Plug with square pin 13x40 ø 60 Embout ø 60 avec axe carré 13x40	TAPPQ60-13x25 TAPPQ60-13x40	Pz Pz		80 80
	Tappo ø 60 con foro ø 14 Plug ø 60 with hole ø 14 Embout ø 60 avec axe rond 14x20	TAPF60	Pz		100
	Calotta ø 40 frangivento tms Caps d.40 For windbreak tms Embout ø 40 brise-vent tms	TAPS40A	Pz		25
	Calotta scorrevole ø 40 tms Caps sliding ø 40 tms Embout coulissant ø 40 tms	TAPSCO40A	Cp		25
	Piedino regolabile tms silver Adjustable foot tms silver Pied tms silver réglable	SLVR-016	Pz		20
	Braccetti tms silver Arms tms silver Bras tms Braccetti tms silver a molla Arms with spring tms silver Bras tms avec ressort	SLVR-030 SLVR-29	Cp		6
	Linguetta per guida tms Tap for guide tms Languette pour guide	TMS0A020	Cp		6
	Scorrevole per guida tms Sliding for guide tms Coulisse pour guide tms Scorrevole per guida tms a molla Sliding for guide a spring tms Coulisse pour guide tms avec ressort	TMSSCORA TMSSCOR-1A	Cp		50

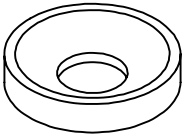
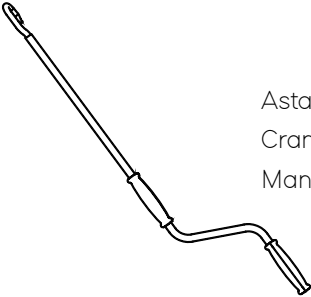
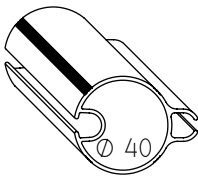
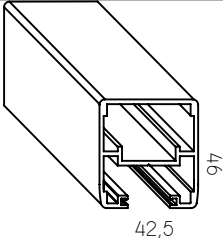
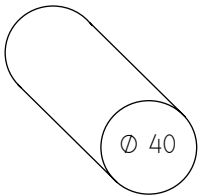
Disegno Figure Dessign	Descrizione Description Description	Codice Article Code Code Article	U.M. Unit	Prezzo unitario Unit price Prix unitaire	Conf. std. Std. pack Cf. std
	Rondella concava Concave washer Rondelle concave	SLVR-020	Pz		10
	Asta di manovra verniciata Crank handle Manivelle	Cm 35 Cm 50 Cm 70 Cm 90 Cm 120 Cm 140 Cm 250 Cm 300	AST0A100 AST0A120 AST0A150 AST0A180 AST0A200 AST0A220 AST0A250 AST0A300	Pz	10
	Terminale tms ø 40 Terminal profile tms ø 40 Barre de charge tms ø 40	Cm 400 Cm 500 Cm 600 Cm 700	TMS4A010 TMS5A010 TMS6A010 TMS7A010	Pz	10
	Guida tms silver Guide allum. Tms silver Guide tms silver	Cm 700	SLVR7A001	Pz	10
	Frangivento tms ø 40 Windbreak tms ø 40 Brise-vent tms/gold ø 40	Cm 400 Cm 500 Cm 600 Cm 700	TMS4A003 TMS5A003 TMS6A003 TMS7A003	Pz	10

Note

A large rectangular area with horizontal dotted lines, intended for writing notes.

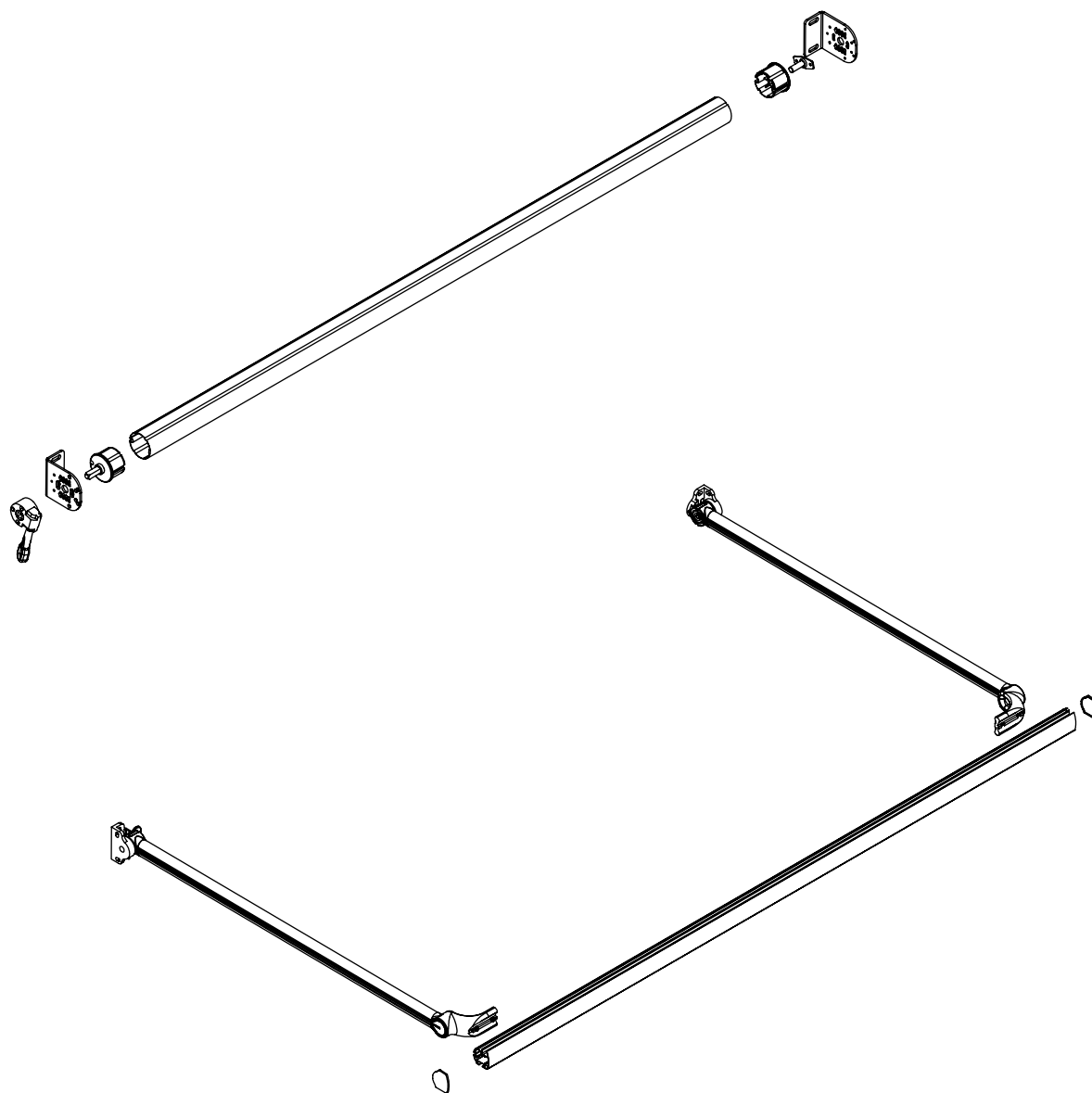

Colori di serie / Standard color / Couleurs standard



Ral
Bianco
9010

Ral
Avorio
1013

Ral
Grigio
7035

Ral
Marrone
8017

Ral
Antracite

Altri colori / Another colors / Autres couleurs +20%

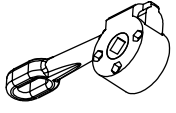
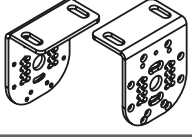
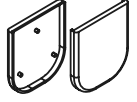
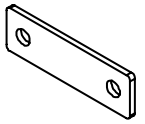
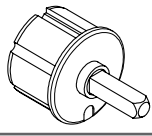
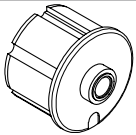
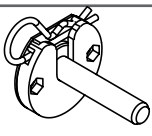
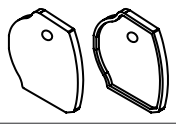
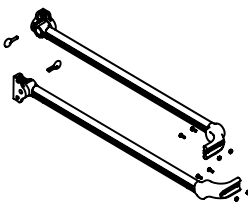
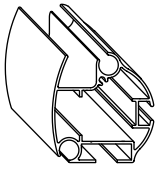
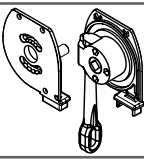
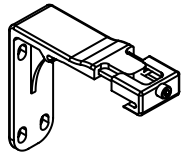
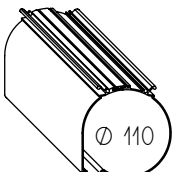
Disegno Figure Design	Descrizione Description Description	Codice Article Code Code Article	U.M. Unit	Prezzo unitario Unit price Prix unitaire	Conf. std. Std. pack Cf. std
	Arganello 11:1 Awning gearbox 11:1 Treuril 11:1	ARG11:1A	Pz		25
	Staffa tnr p/s nuda Bracket tnr wall/ceiling simple Support tnr mur/plafond simple	TNRS0A006	Cp		50
	Cuffie per staffe tnr Bushing for pivot arm tnr Bouchons pour supports tnr	COA002	Cp		100
	Contropiastrina Counterplate Contre-plaque	PCF0003	Pz		100
	Tappo ø 60 con perno quadro 13x25 Plug with square pin 13x25 ø 60 Embout ø 60 avec ax carré 13x40	TAPPQ60-13x25	Pz		80
	Tappo ø 60 con foro ø 14 Plug ø 60 with hole ø 14 Embout ø 60 avec trou ø 40	TAPF60	Pz		100
	Piastrina in nylon con perno estraibile Plate nylon with removable pin Plaquette en nylon avec axe extraible	PES-0005	Pz		100
	Tappi per terminale 30600 con viti Plug for terminal profile model 30600 Bouchons barre de charge 30600 avec vis	KIR0A025	Cp		100
		Cm 80	TMB0A080		
		Cm 100	TMB0A100		
	Braccetti tb firenze Arms tb firenze Bras tb firenze	Cm 120	TMB0A120	Cp	5
		Cm 140	TMB0A140		
		Cm 160	TMB0A160		
	Terminale 30600 Terminal profile 30600 Barre de charge 30600	Cm 400	KIR4A001		
		Cm 500	KIR5A001	Pz	10
		Cm 600	KIR6A001		
		Cm 700	KIR7A001		
	Tappi cassonetto ad arganello 4,7:1 Gambo lungo 4.7: 1 gear box caps with long stem 4.7: 1 capuchons de boîte de vitesses à longue tige		TCN0A010	Cp	50
	Supporto parete cassonetto Support box for wall Support mur pour coffre tcn		TCN0A0005	Pz	100
	Cassonetto di protezione TMS Box of protection tms Boîte de protection TMS	Cm 300	TCNCASS3A	Pz	10
		Cm 700	TCNCASS7A		
	1884gr/ml				

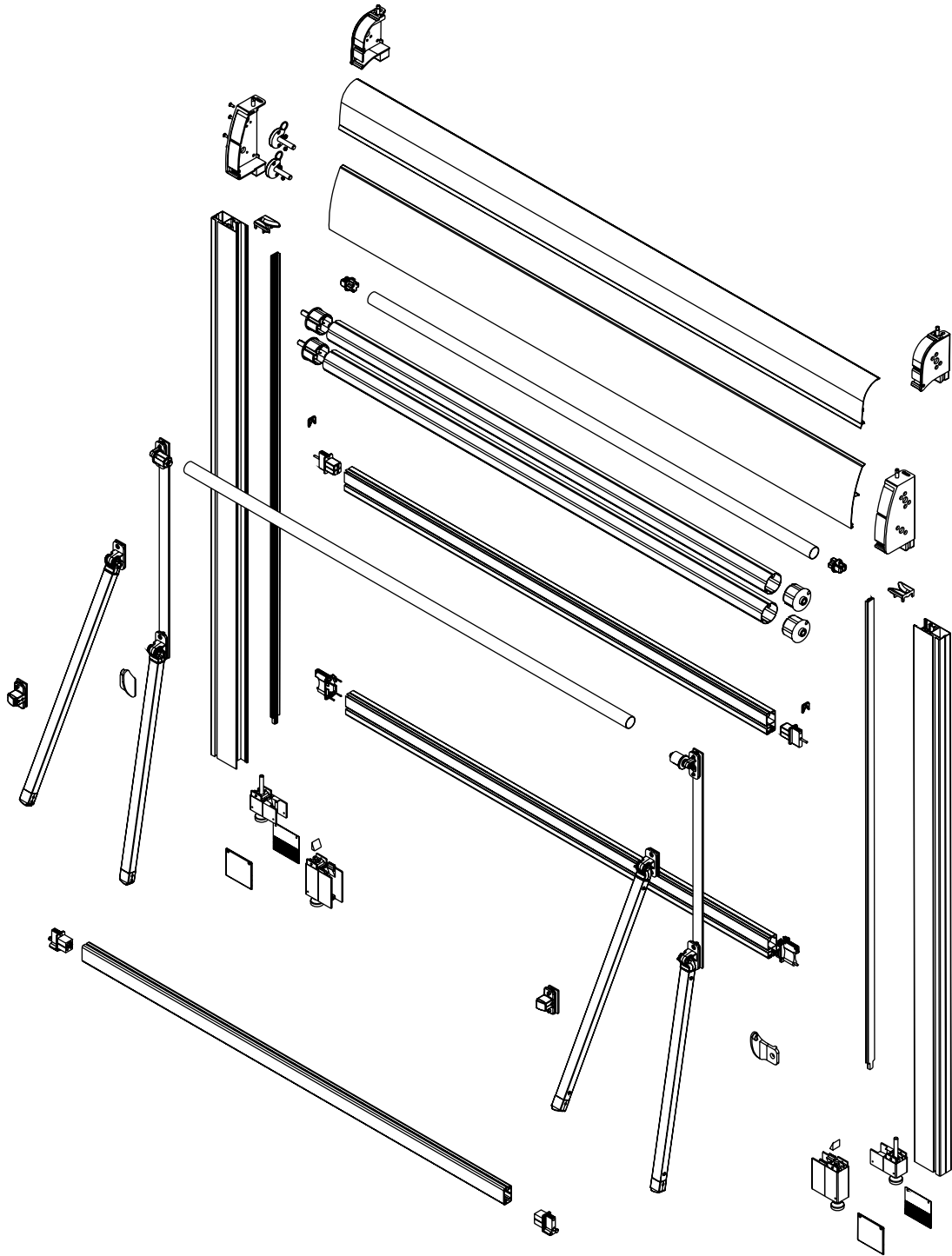

Colori di serie / Standard color / Couleurs standard





Ral
Bianco
9010

Ral
Avorio
1013

Ral
Bronzo

Ral
Grigio
7035

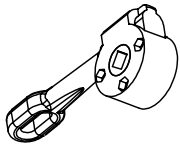
Altri colori / Another colors / Autres couleurs +20%

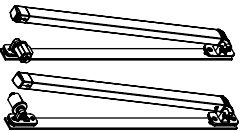
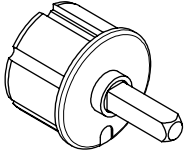
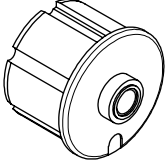
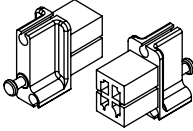
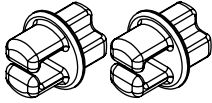
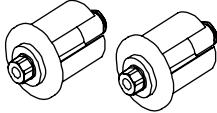
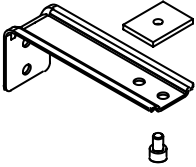
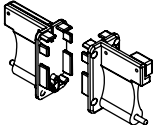
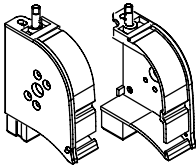
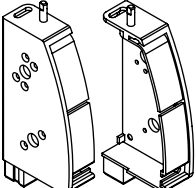
Disegno Figure Design	Descrizione Description Description	Codice Article Code Code Article	U.M. Unit	Prezzo unitario Unit price Prix unitaire	Conf. std. Std. pack Cf. std
	Arganello 11:1 Awning gearbox 11:1 Trebil 11:1	ARG7:1A	Pz		25
	Braccetti p-gold Arms p-gold Bras gold	Cm 85 GOBRA0085A Cm 95 GOBRA0095A	Cp		5
	Braccetti scorrevoli p-gold Sliding arms p-gold Bras coulissants p-gold	Cm 73 GOBRA0073S-A Cm 85 GOBRA0085S-A Cm 95 GOBRA0095S-A	Cp		5
	Tappo ø 70 con perno quadro 13x40 Plug with square pin 13x40 ø 70 Embout ø 70 avec axe carré 13x40	TAPPQ70-13x40	Pz		80
	Tappo ø 70 con foro ø 14 Plug ø 70 with hole ø 14 Embout ø 70 avec trou ø 14	TAPF70	Pz		200
	Tappo terminale estivo p-gold Plug terminal profile summer p-gold Bouchons barre de charge gold	GOLD-023	Cp		10
	Calotta frangivento invernale Windbreak cap winter Embout brise-vent hivernal	GOLD0001A	Cp		10
	Calotta frangivento estiva Summer windbreak cap Embout brise-vent estival	GOLD0003A	Cp		10
	Staffa a "L" completa di piastrina bullone e dado "L" bracket complete with bolt plate and nut Support à "L" pour gold caomplet de plaquette, boulon et écrou	GOLD0A004	Pz		20
	Tappo terminale invernale zip Plug for winter terminal zip Bouchon d'hiver zip	GOLD-138	Cp		10
	Tappi carter p-gold 1 rullo 1-roll p-gold carter caps Casquettes 1 rouleau P-Gold Carteru	GOLD-129	Cp		10
	Tappi carter p-gold 2 rulli Carter caps p-gold 2 rollers Carter Caps P-Gold 2 rouleaux	GOLD-228	CP		10

Disegno Figure Dessign	Descrizione Description Description	Codice Article Code Code Article	U.M. Unit	Prezzo unitario Unit price Prix unitaire	Conf. std. Std. pack Cf. std
------------------------------	---	--	--------------	--	------------------------------------

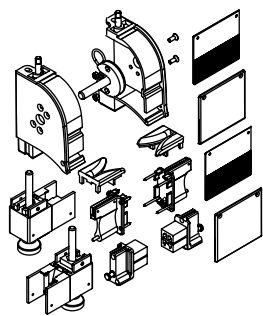

Kit accessori Gold 1 rullo
Gold zip 1 roller accessory kit
Gold zip 1 kit d'accessoires de rouleau

KIT.GOLDZIP1R.A

Pz

6

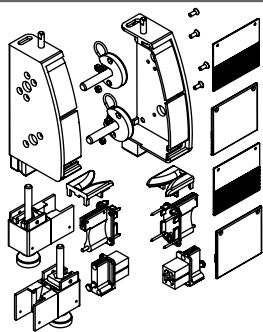

Kit accessori Gold 2 rulli
Gold zip 2 roller accessory kit
Gold zip 2 kit d'accessoires de rouleau

KIT.GOLDZIP2R.A

Pz

6

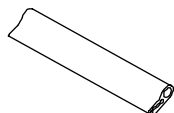

Guarnizione per carter
Seal for carter
Joint pour carter

GOLD001

MI

50

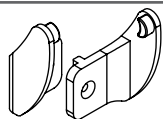

Fermo per braccetto scorrevole completo di piastrina
Latch gold for sliding plate
Arrêt pour bras coulissant

GOLD0A008

Cp

10

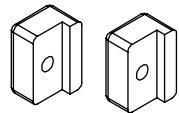

Tacchetti per bloccaggio frangivento
Studs for locking windbreak gold
Clou pour blocage brise-vent

GOLD0002

Cp

20



Spazzolino mm. 5X9 per guida
Brush 6x9
Brosse mm. 5X9 pour guide

ZANZ008

MI

650

26



Asta di manovra verniciata
Crank handle
Manivelle

Cm 35 AST0A100

Cm 50 AST0A120

Cm 70 AST0A150

Cm 90 AST0A180

Cm 120 AST0A200

Cm 140 AST0A220

Cm 250 AST0A250

Cm 300 AST0A300

Pz

10

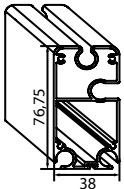
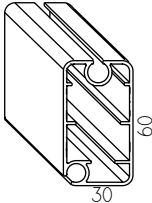
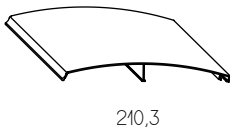
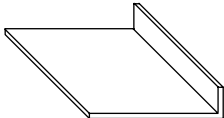
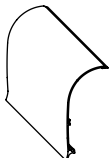
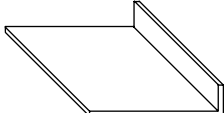
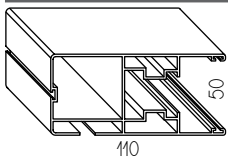
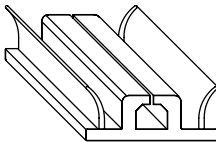
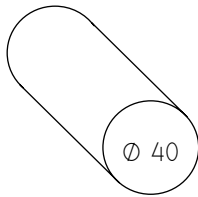
Disegno Figure Design	Descrizione Description Description		Codice Article Code Code Article	U.M. Unit	Prezzo unitario Unit price Prix unitaire	Conf. std. Std. pack Cf. std
	Terminale omega invernale con zip	Cm 400	TCL4A002			
	Winter omega terminal with zip	Cm 500	TCL5A002	Pz		10
	Omega terminal d'hiver avec zip	Cm 700	TCL7A002			
	1819gr/ml					
	Terminale p-gold estate inverno senza zip	Cm 700	TCLB7A001	Pz		10
	Terminal p-gold summer winter without zip					
	Barre de charge p-gold					
	1045gr/ml					
	Carter p-gold 2 rulli	Cm 400	KITCASSTA004	Pz		10
	Carter p-gold 2 rollers	Cm 600	KITCASSTA006	Pz		10
	Carter p-gold 2 rouleaux					
	1463gr/ml					
	Carter interno p-gold 2 rulli	Cm 600	KITCASSIN6A	Pz		10
	Internal casing p-gold 2 rollers					
	Boîtier interne p-or 2 rouleaux					
	Carter p-gold 1 rullo	Cm 600	CART1R6A	Pz		
	Carter p-gold 1 roller	Cm 400	CART1R4A	Pz		
	Carter p-gold 1 rouleau					
	1275gr/ml					
	Carter interno p-gold 1 rullo	Cm 600	CARTINT6A	Pz		10
	Internal casing p-gold 1 roller					
	Boîtier interne p-or 1 rouleau					
	Guida p-gold	Cm 500	P-G5A			
	Guide p-gold			Pz		10
	Guide p-gold	Cm 700	P-G7A			
	2043gr/ml					
	Slim per guida	Cm 500	TCL5A007	Pz		7
	Slim for guide	Cm 700	TCL7A007			
	Slim for guide					
	Frangivento p-gold ø 40	Cm 400	TMS4A003			
	Windbreak p-gold ø 40	Cm 500	TMS5A003			
	Brise-vent tms/gold ø 40	Cm 600	TMS6A003	Pz		10
		Cm 700	TMS7A003			
	515gr/ml					

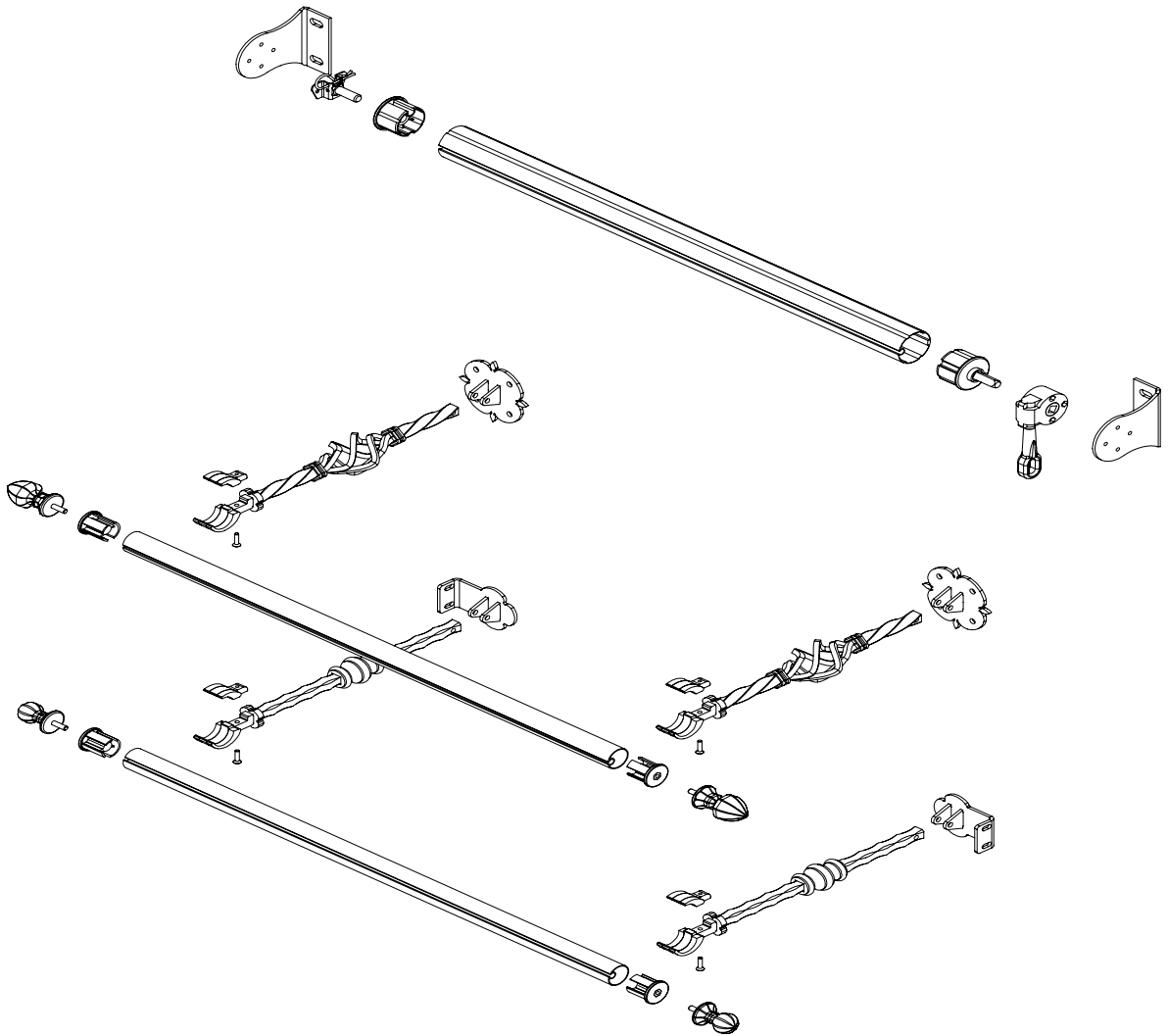

Colori di serie / Standard color / Couleurs standard







Arabescato
Rame

Arabescato
Grigio

Il materiale è pre-zincato elettroliticamente prima della verniciatura.

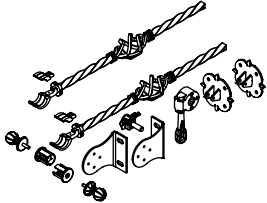
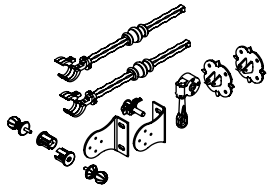
The material is pre-galvanized electrolytically before painting.

Altri colori / Another colors / Autres couleurs +20%

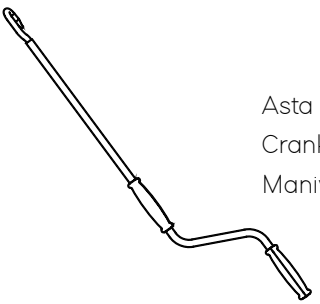
Disegno Figure Design	Descrizione Description Description	Codice Article Code Code Article	U.M. Unit	Prezzo unitario Unit price Prix unitaire	Conf. std. Std. pack Cf. std
	Kit retro' attorcigliato Kit retro' twisted Kit retro' entortillé	Cm 70	RETRO 560 ATT	Pz	5
		Cm 90	RETRO 760 ATT		
		Cm 110	RETRO 960 ATT		
		Cm 130	RETRO 1160 ATT		
		Cm 150	RETRO 1360 ATT		
	Kit retro' quadro Kit retro' square Kit retro' carré	Cm 70	RETRO 560 QUA	Pz	5
		Cm 90	RETRO 760 QUA		
		Cm 110	RETRO 960 QUA		
		Cm 130	RETRO 1160 QUA		
		Cm 150	RETRO 1360 QUA		
 Ø 40	Terminale tortiglione Terminal profile tortiglione Barre de charge tortiglione	Cm 300	RETRO3STERM	Pz	10
		Cm 400	RETRO4STERM		
		Cm 500	RETRO5STERM		
	Tettino di protezione Canopy of protection m3 Auvent de protection	Cm 300	RETRO3STETTINO	Pz	1
		Cm 400	RETRO4STETTINO		
		Cm 500	RETRO5STETTINO		
(zincato e verniciato fino a 4 mt, oltre 4 mt. in alluminio) / (galvanized and painted up to 4 m, over 4 m aluminum) (galvanisé et peint jusqu'à 4 mt, plus de 4 mt. en aluminium)					
	Tappi per tettino Caps for roof Bouchons pour auvent		RETROTAPPI	Cp	1
	Asta di manovra verniciata Crank handle Manivelle	Cm 35	AST0A100	Pz	10
		Cm 50	AST0A120		
		Cm 70	AST0A150		
		Cm 90	AST0A180		
		Cm 120	AST0A200		
		Cm 140	AST0A220		
		Cm 250	AST0A250		
Cm 300	AST0A300				

VENEZIA

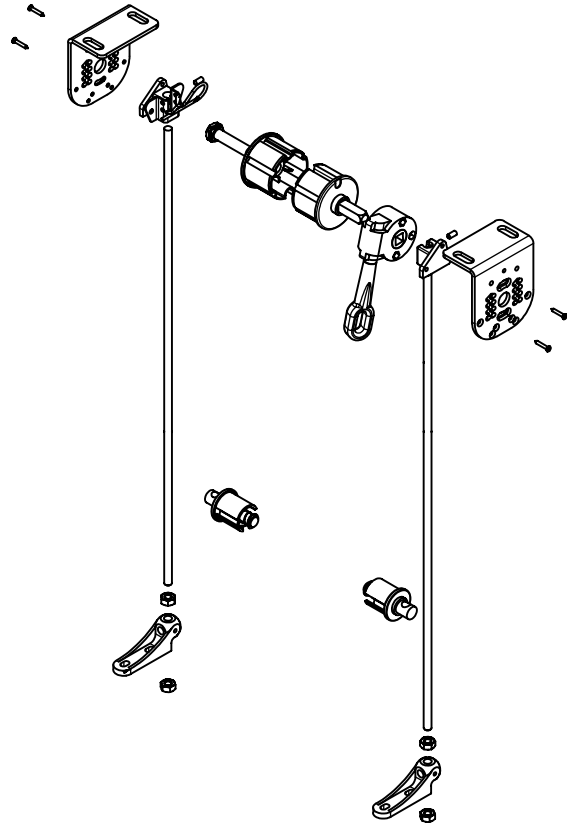
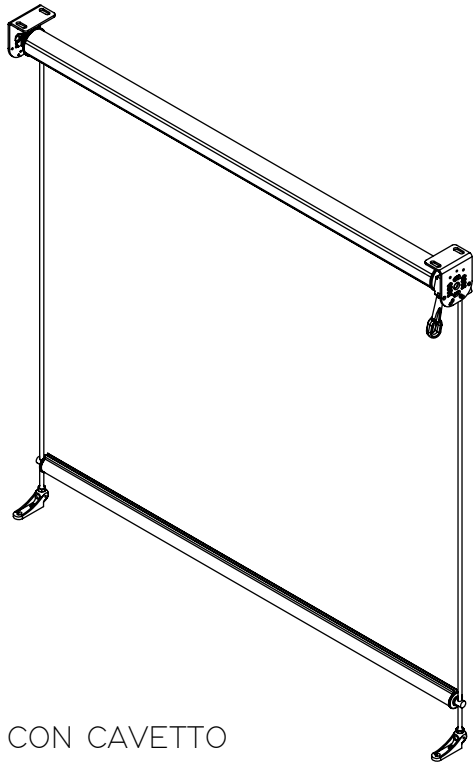

VENEZIA CON CAVETTO
VENEZIA WITH CABLE
VENEZIA AVEC CABLE

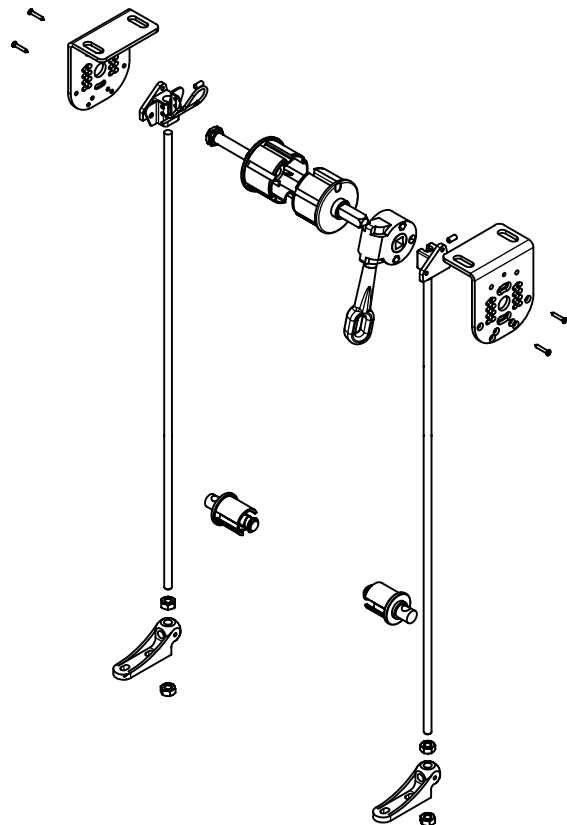
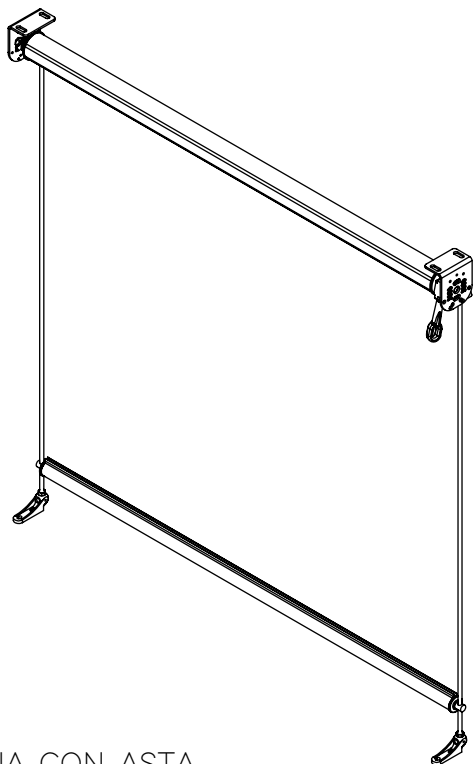

VENEZIA CON ASTA
VENEZIA ROD
VENEZIA AVEC TIGE

Colori di serie / Standard color / Couleurs standard



Ral
Bianco
9010

Ral
Avorio
1013

Ral
Grigio
7035

Altri colori / Another colors / Autres couleurs +20%

VENEZIA CASSONETTO TONDO

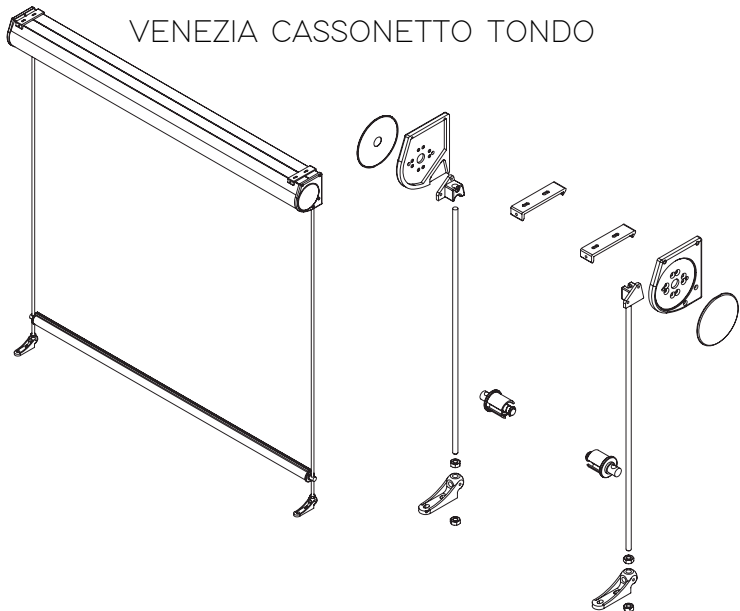



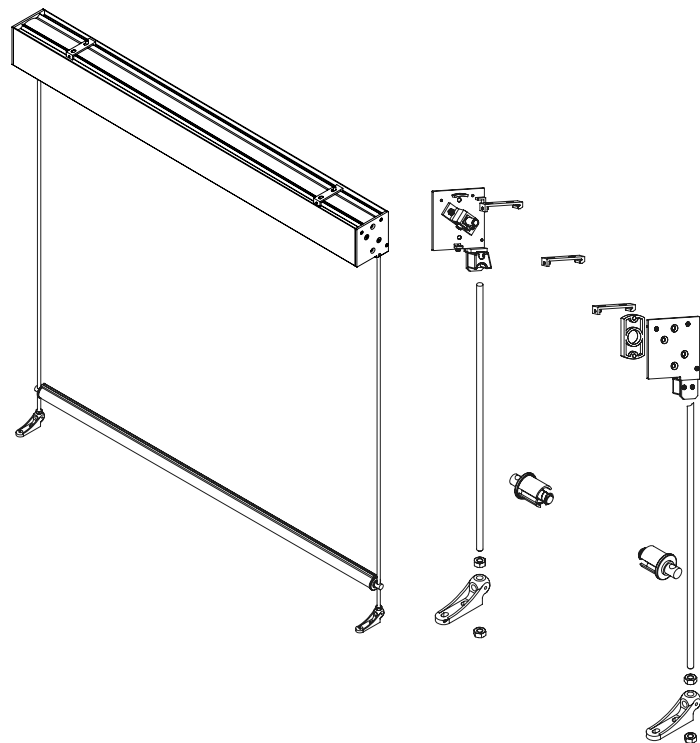

VENEZIA CASSONETTO QUADRO

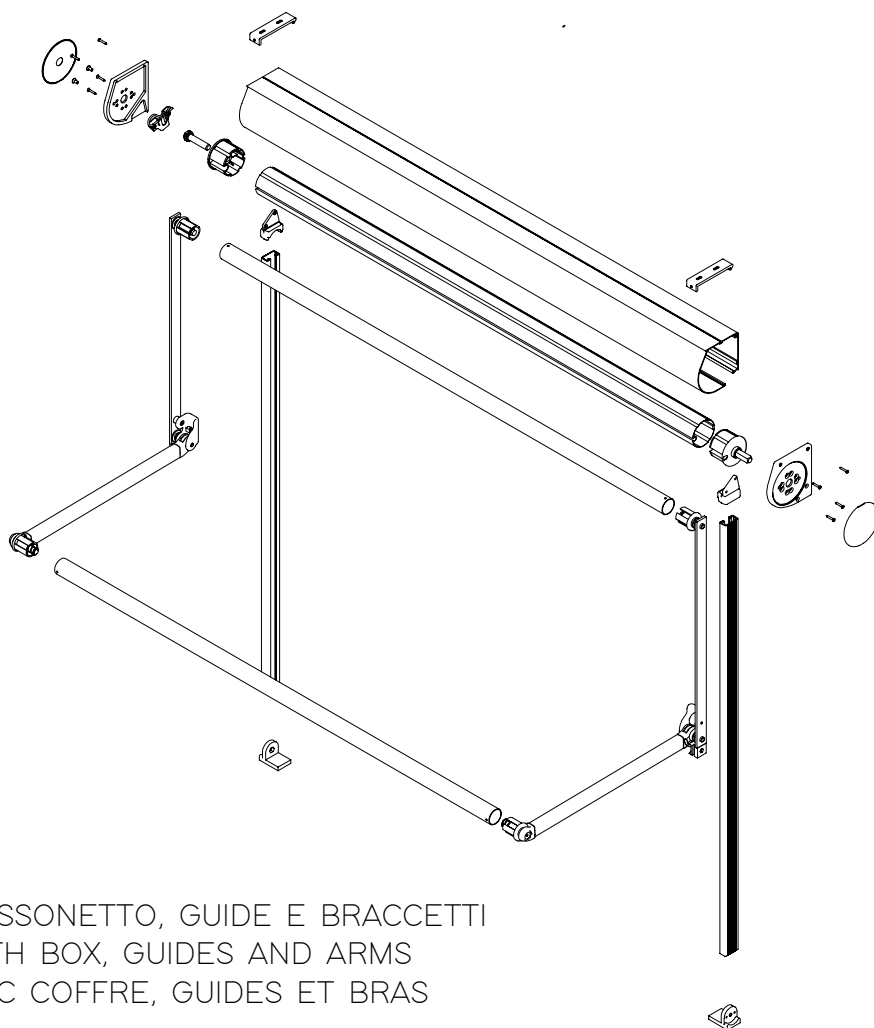

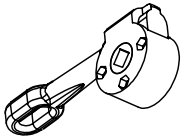
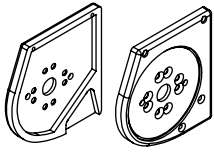
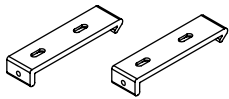
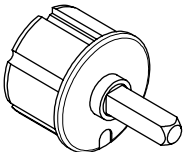
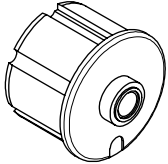
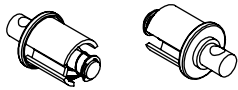
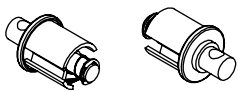

VENEZIA CON CASSONETTO E CAVETTO / ASTA
 VENEZIA WITH BOX AND CABLE / ROD
 VENEZIA WITH BOX AND CABLE / TIGE

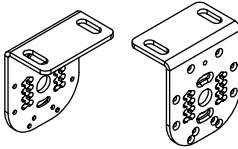
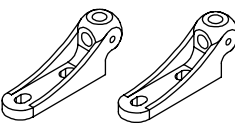

VENEZIA CON CASSONETTO, GUIDE E BRACCETTI
 VENEZIA WITH BOX, GUIDES AND ARMS
 VENEZIA AVEC COFFRE, GUIDES ET BRAS

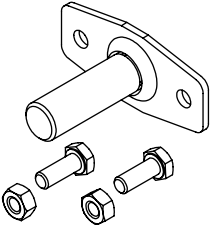
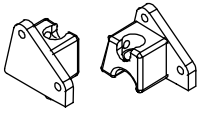
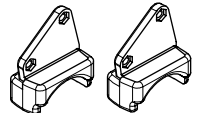
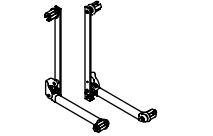
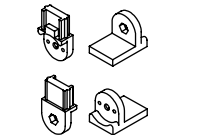
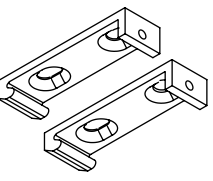
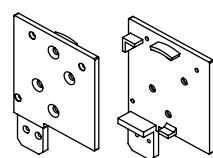
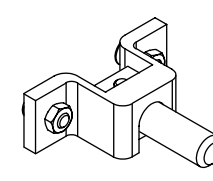
Disegno Figure Dessign	Descrizione Description Description		Codice Article Code Code Article	U.M. Unit	Prezzo unitario Unit price Prix unitaire	Conf. std. Std. pack Cf. std
	Arganello 11:1 Awning gearbox 11:1 Treuil 11:1		ARG11A	Pz		25
	Tappi cassonetto tcl/venezia Caps for box tcl/venezia Bouchons coffre tcl/venezia		TCL0025A	Cp		10
	Supporti cassonetto tcl/venezia Support for box tcl/venezia Supports coffre tcl/venezia		TCL0A015	Cp		10
	Tappo ø 70 con perno quadro 13x40 Plug with square pin 13x40 ø 70 Embout ø 70 avec axe carré 13x40		TAPPQ70-13x40	Pz		80
	Tappo ø 70 con foro ø 14 Plug ø 70 with hole ø 14 Embout ø 70 avec trou ø 14		TAPF70	Pz		200
	Calotta ø 40 per cavetto guida ø 4 mm Caps d.40 For cable guide ø 4 mm Embout ø 40 pour cable guide ø 4 mm		TAPCAV40A	Cp		10
	Calotta ø 40 per asta guida ø 10 mm Cap ø 40 for rod guide ø 10 mm Embout ø 40 pour tige guide ø 10 mm		TAPAST40A	Cp		10
	Calotta ø 40 per asta /cavo con fermo Cap ø 40 for rod cable still Embout ø 40 pour tige/cable avec arrêt		TAPBLOK40	Cp		10
	Cavetto guida inox ø 4 mm con vite e morsetto Cable guide inox ø 4 with screws and clamp Cable guide inox ø 4 mm avec vis et pinces	Cm 100 Cm 200 Cm 300	VEN1A005 VEN2A005 VEN3A005			10
	Asta guida inox ø 10 mm con vite Rod guide inox ø 10 with screws Tringle guide inox ø 10 mm avec vis	Cm 100 Cm 200 Cm 300	VEN1A006 VEN2A006 VEN3A006			10
	Staffa p/s venezia Bracket p/s venezia Bride p/s venezia		TNRS0A006	Cp		25
	Piedini universali per asta e cavetto Universal feet for rod and cable Pieds universels pour tige et câble	Asta Cavetto	DROP0A007 DROP0A008			10

Disegno Figure Design	Descrizione Description Description		Codice Article Code Code Article	U.M. Unit	Prezzo unitario Unit price Prix unitaire	Conf. std. Std. pack Cf. std
PIASTRINA CON PERNO / PLATE WITH PIN / PLAQUE AVEC AXE						
	Senza bulloni e dadi Without bolts and nuts	14x40	PCP00001	Pz		100
	Sans boulons et écrous Con bulloni M6x16 e dadi M6	14x75	PCP00002			
	With bolts and nuts M6x16 e dadi M6	14x40	PCP00003			
	Avec boulons et écrous M6x16 e dadi M6	14x75	PCP00004			
	Inserto superiore cavo/asta Upper cable / rod insert Insert supérieur cable/tringle		VNZ-008A	Cp		10
	Inserto superiore guida Upper guide insert Insert supérieur guide		VNZ-010A	Cp		10
	Braccetti tms a molla Awning arms with spring tms Bras avec ressort		TMS0A005	Cp		10
	Piedino singolo Leg single Pied simple		TMS0A006	Cp		10
	Supporti cassonetto quadro Square box supports Supports de boîte carrée		TCLO-003	Cp		10
	Tappi cassonetto quadro Caps for box tcl Bouchons coffre tcl		TCLO-030	Cp		5
	Perno estraibile cassonetto quadro Square box removable pin Broche amovible boîte carrée		TCLO-005	Pz		5
		Cm 35	AST0A100	Pz		10
		Cm 50	AST0A120			
		Cm 70	AST0A150			
		Cm 90	AST0A180			
		Cm 120	AST0A200			
		Cm 140	AST0A220			
		Cm 250	AST0A250			
	Cm 300	AST0A300				

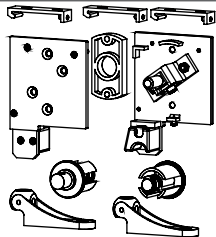
Disegno Figure Design	Descrizione Description Description		Codice Article Code Code Article	U.M. Unit	Prezzo unitario Unit price Prix unitaire	Conf. std. Std. pack Cf. std
	Kit venezia cassonetto tondo Kit venezia with box round Kit venezia boîte ronde		Cavetto KIT VENCAV-A	Pz		10
	Kit venezia cassonetto tondo Kit venezia with box round Kit venezia boîte ronde		Asta KIT.VENAST	Pz		10
	Kit venezia cassonetto quadro Kit venezia square box Kit venezia carré boîte		Cavetto KIT.VENCCQ	Pz		10
	Kit venezia cassonetto quadro Kit venezia square box Kit venezia carré boîte		Asta KIT.VENACQ	Pz		10
	Terminale tms \varnothing 40 Terminal profile tms \varnothing 40 Barre de charge tms/gold \varnothing 40 725gr/ml	Cm 400 Cm 500 Cm 600 Cm 700	TMS4A010 TMS5A010 TMS6A010 TMS7A010	Pz		10
	Guida tms Guide allum. Tms Guide tms 610gr/ml	Cm 700	TMSA700	Pz		10
	Frangivento p-gold \varnothing 40 Windbreak p-gold \varnothing 40 Brise-vent p-gold \varnothing 40 515gr/ml	Cm 400 Cm 500 Cm 600 Cm 700	TMS4A003 TMS5A003 TMS6A003 TMS7A003	Pz		10
	Cassonetto di protezione Box of protection Coffre de protection 2339gr/ml	Cm 400 Cm 500 Cm 700	TCL4A003 TCL5A003 TCL7A003	Pz		10
	Cassonetto di protezione quadro Square protection box Coffre de protection carrée 2237gr/ml	Cm 400 Cm 500 Cm 700	TCLO4A001 TCLO5A001 TCLO7A001	Pz		10

Note

A large rectangular area with horizontal dotted lines, intended for writing notes.

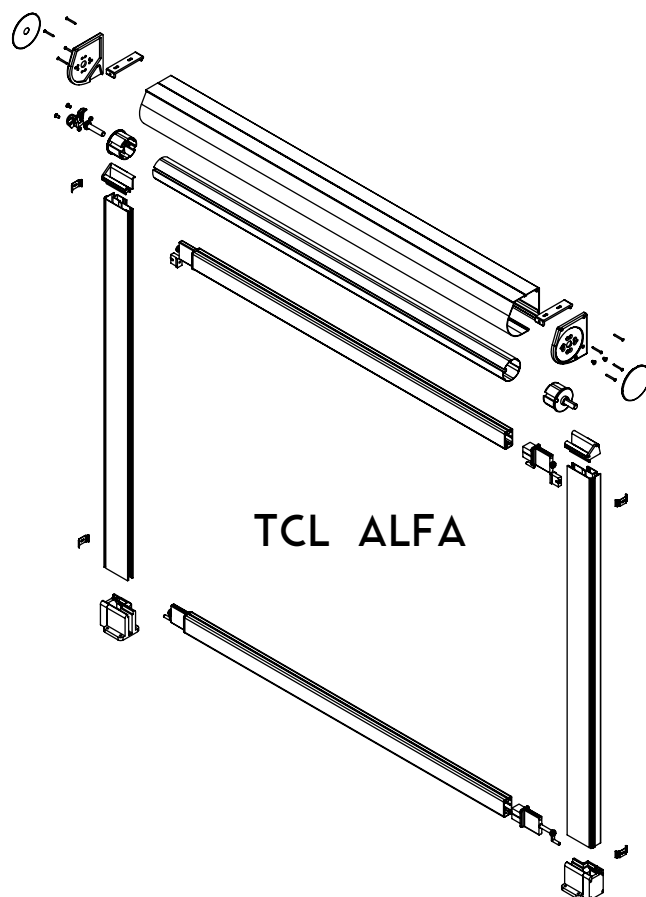

TCL ALFA

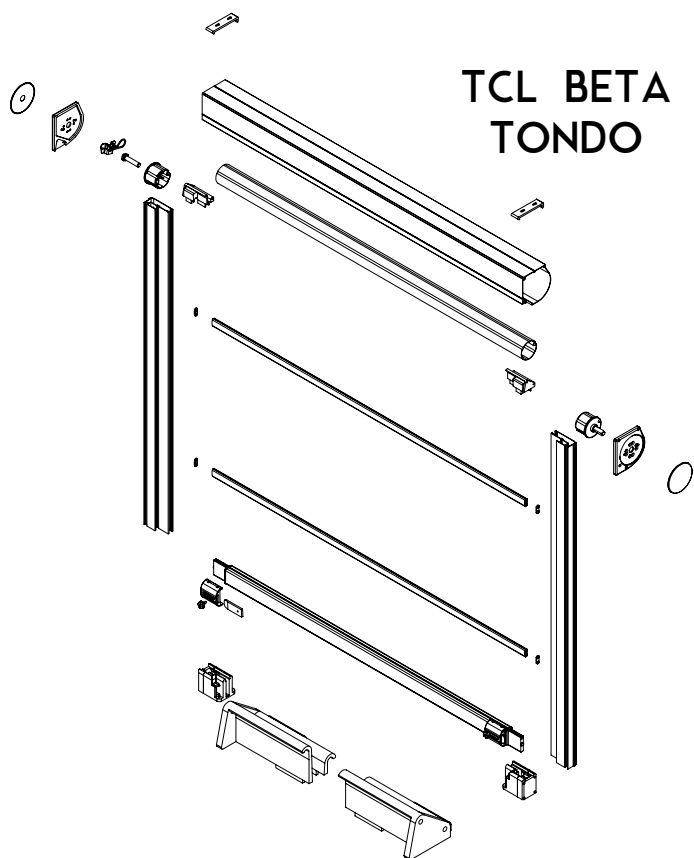

TCL BETA TONDO

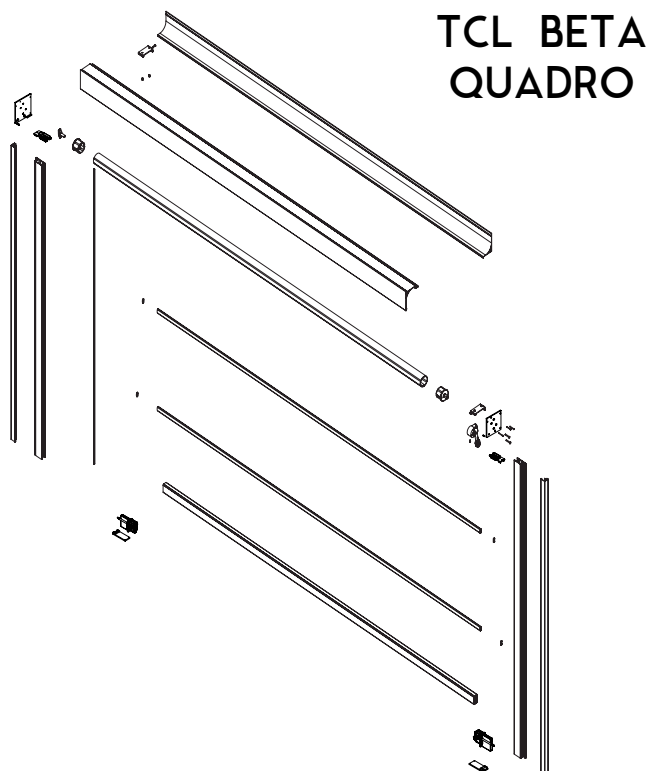

TCL BETA QUADRO

Colori di serie / Standard color / Couleurs standard



Ral
Bianco
9010

Ral
Avorio
1013

Ral
Grigio
7035



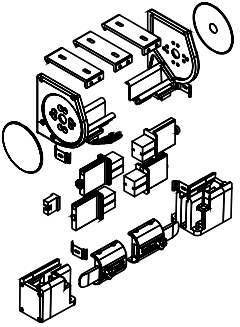
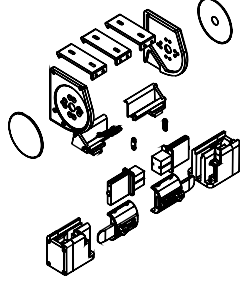
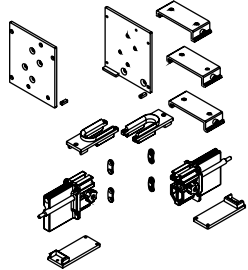
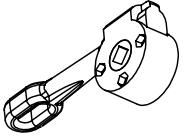
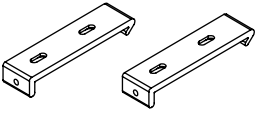
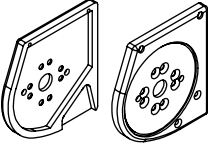
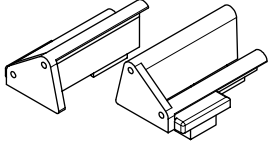
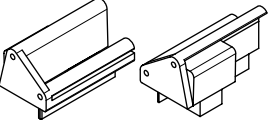

Ral
Marrone
8017

Ral
Corten

Altri colori / Another colors / Autres couleurs +20%

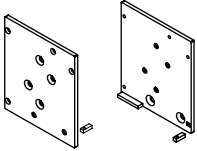
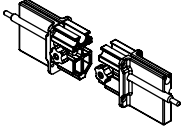
Disegno Figure Design	Descrizione Description Description	Codice Article Code Code Article	U.M. Unit	Prezzo unitario Unit price Prix unitaire	Conf. std. Std. pack Cf. std
	Kit accessori TCL ALFA TCL ALFA accessory kit Kit d'accessoires TCL ALFA	KIT-TCLA	Pz		1
	Kit accessori TCL BETA Cass.Tondo TCL BETA Round Cassette Accessory Kit Kit d'accessoires TCL BETA Boîte ronde	KIT-TCLBT	Pz		1
	Kit accessori TCL BETA Cass.Quadro TCL BETA Cass.Quadro accessory kit TCL BETA Cass.Quadro kit d'accessoires	KIT-TCLBQ	Pz		1
	Arganello 7:1 Awning gearbox 7:1 Treuil 7:1	ARG7:1A	Pz		25
	Supporti cassonetto tcl/venezia Support box tcl / venezia allum. Supports coffre tcl/venezia	TCL0A015	Cp		10
	Tappi cassonetto tcl Caps for box tcl/venezia Bouchons coffre tcl/venezia	TCL0025A	Cp		5
	Innesto superiore per guida tcl Cassonetto tondo esterno Graft support guide tcl allum. Box outer round Support supérieur pour guide tcl Coffre rond extérieur	TCL0A044	Cp		5
	Innesto superiore per guida tcl Cassonetto tondo interno Graft support guide tcl allum. Box inner round Support supérieur pour guide tcl Coffre rond intérieur	TCL0022	Cp		5

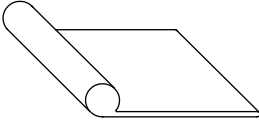
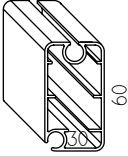
Disegno Figure Dessign	Descrizione Description Description	Codice Article Code Code Article	U.M. Unit	Prezzo unitario Unit price Prix unitaire	Conf. std. Std. pack Cf. std
	Piedino per guida tcl con aggancio Catenacciolo Leg for guide allum. Tcl with Hooking latch Pied pour guide tcl avec accrochage loquet	TCL0001C-A	Cp		5
	Catenacciolo Latch allum. tcl Loquet	TCL0A001	Cp		5
	Piastrina con perno 14x40 Plate with pin 14x40 Plaquette avec axe 14x40	PCP00001	Pz		100
	Tacchetto per bloccaggio frangivento Cleat for locking windbreak Clou pour blocage brise-vent	TCL0028A	Pz		20
	Tappi terminale tcl manuale Caps terminal tcl manuale Bouchons barre de charge tcl manual	TCL0018A	Cp		5
	Tappo frangivento Caps windbreak tcl Bouchon brise-vent	TCL0027A	Cp		5
	Tappo ø 70 con perno quadro 13x25 Plug with square pin 13x25 ø 70 Embout ø 70 avec axe carré 13x25	TAPPQ70-13x25	Pz		5
	Tappo con foro ø 70 Plug ø 70 with hole ø 14 Embout avec trou ø 70	TAPF70	Pz		200
	Tappo terminale frangivento tcl beta Plug windbreak terminal tcl beta Capuchon coupe-vent tcl beta	TCL0A005	Cp		10
	Fermo a scatto per guida Anchorage overhead for insect Screen with spring Arrêt pour guide	ZANZ046	Pz		20
	Supporto soffitto x cass quadro Celing support for squared box Support de plafond pour panneau carré	TCLZ-014	Pz		5
	Innesto superiore per guida tcl Cassonetto quadro Upper clutch for tcl Square box Raccord supérieur pour guide tcl Boîte carrée	TCLB-101	Cp		5
	Perno estraibile cassonetto quadro Square box removable pin Broche amovible boîte carrée	TCL0-005	Pz		5
	Piedino per guida tcl con Catenacciolo Foot for tcl guide with Catenacciolo Pied pour guide tcl avec catenacciolo	TCLB-021	Cp		5

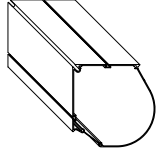
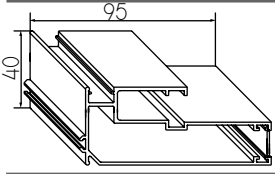
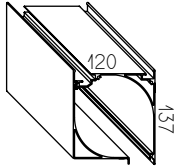
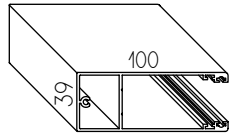
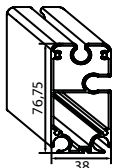
Disegno Figure Design	Descrizione Description Description		Codice Article Code Code Article	U.M. Unit	Prezzo unitario Unit price Prix unitaire	Conf. std. Std. pack Cf. std
	Tappi cassonetto quadro 13 x 13 Square box caps 13 x 13 Capsules carrées 13 x 13		TCLB-100	Cp		5
	Tappi terminale tcl manuale Caps terminal tcl manuale Embouts manuels tcl		TCLB-011	Cp		5
	Spazzolino / brush / brosse 5mm		TCL-018	MI		1000
	Spazzolino / brush / brosse 9mm		TCL-017			650
	Spazzolino / brush / brosse 11mm		TCL-016			600
	Spazzolino a 45°/brush 45°/brosse 45°		TCL-019			500
	Guarnizione terminale Terminal profile gasket Joint terminal		TCL0013	MI		50
	Guarnizione terminale Terminal profile gasket Joint terminal		TCL0017	MI		50
	Terminale frangivento tcl	Cm 400	TCL4A002	Pz		10
	Terminal windbreak tcl	Cm 500	TCL5A002			
	Barre de charge brise-vent tcl	Cm 700	TCL7A002			
		1045gr/ml				
	Frangivento tcl beta Windbreak tcl beta Brise-vent tcl beta	Cm 700	TCL7A005	Pz		10
		306gr/ml				
	Cassonetto di protezione	Cm 400	TCL4A003	Pz		10
	Box of protection	Cm 500	TCL5A003			
	Coffre de protection	Cm 700	TCL7A003			
		2339gr/ml				
	Guida laterale tcl	Cm 450	TCL4,5A001	MI		10
	Guide side tcl	Cm 600	TCL6A001			
	Guide tcl					
		1457gr/ml				
	Cassonetto di protezione quadro	Cm 400	TCL4A003GAM	Pz		10
	Square protection box	Cm 500	TCL5A003GAM			
	Coffre de protection carrée	Cm 700	TCL7A003GAM			
		2339gr/ml				
	Guida laterale tcl Beta quadro Guide side tcl Guide tcl carrée	Cm 500	TCLB5A00	Pz		10
		1641gr/ml				
	Terminale tcl	Cm 400	TCL4A002	Pz		10
	Terminal tcl	Cm 500	TCL5A002			
	Barre de charge tcl	Cm 700	TCL7A002			
		1045gr/ml				

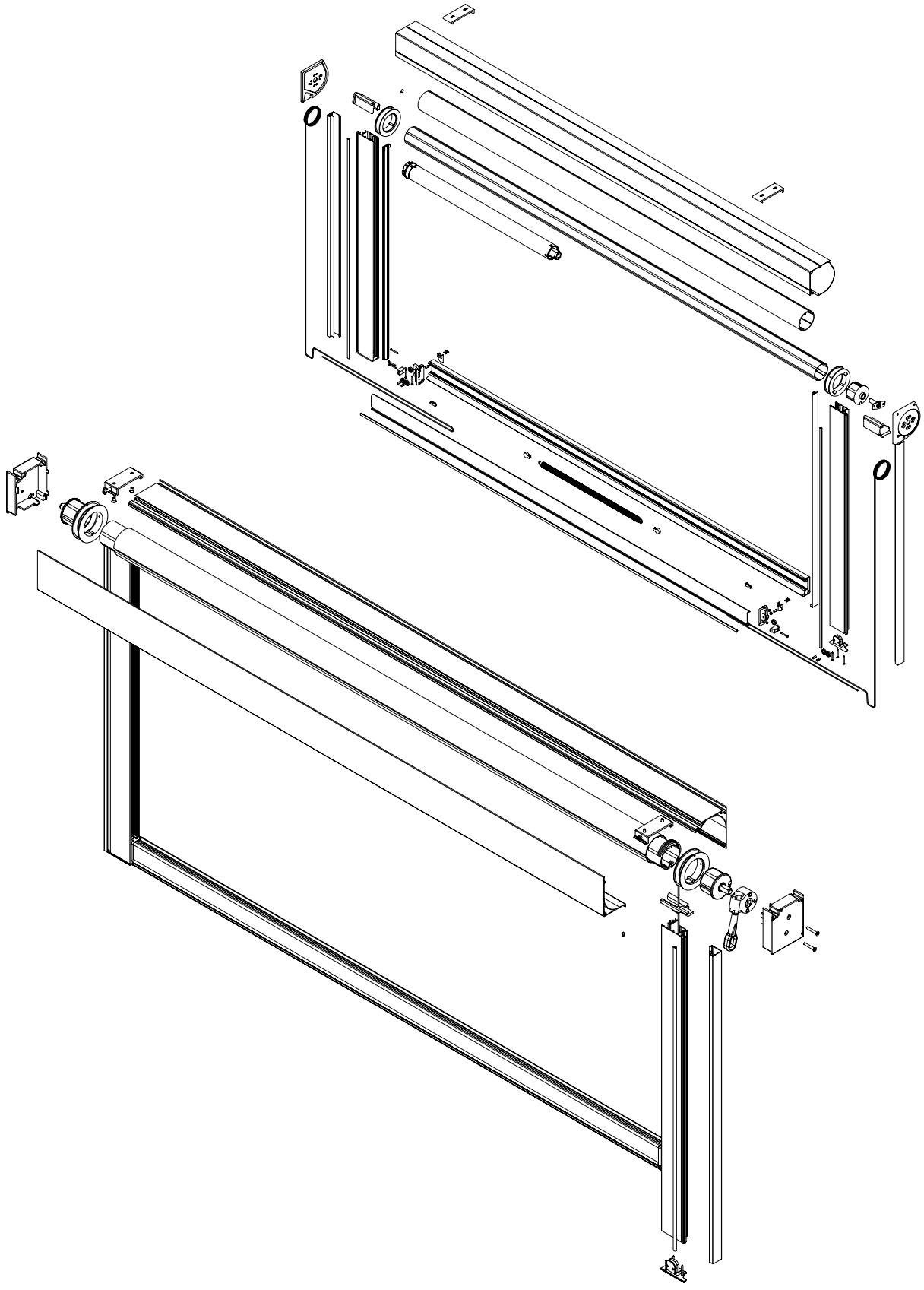

Colori di serie / Standard color / Couleurs standard





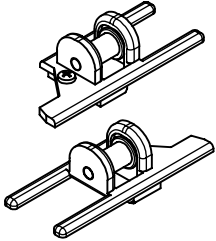
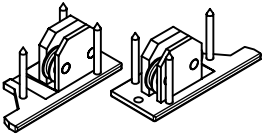
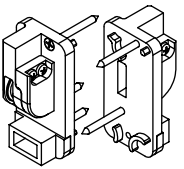
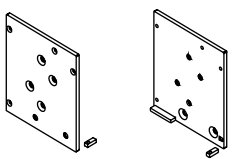
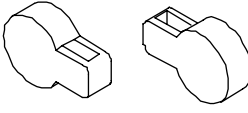
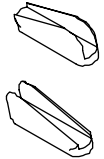
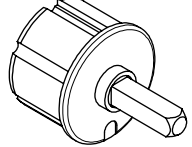
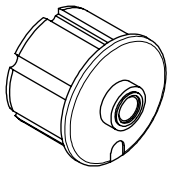
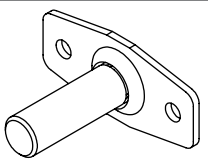
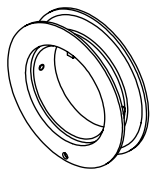
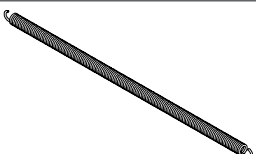

- | | | | | |
|-----------------------|-----------------------|-----------------------|------------------------|---------------|
| Ral
Bianco
9010 | Ral
Avorio
1013 | Ral
Grigio
7035 | Ral
Marrone
8017 | Ral
Corten |
|-----------------------|-----------------------|-----------------------|------------------------|---------------|

Altri colori / Another colors / Autres couleurs +20%

Disegno Figure Design	Descrizione Description Description	Codice Article Code Code Article	U.M. Unit	Prezzo unitario Unit price Prix unitaire	Conf. std. Std. pack Cf. std
	KIT TCL Gamma cassonetto Quadro KIT TCL Quadro box range KIT TCL Quadro box gamme	KIT-TCLCQ	Pz		1
	KIT TCL Gamma cassonetto Tondo TCL KIT Round box range TCL KIT Gamme de boîtes rondes	KIT-TCLBT	Pz		1
	Arganello 7:1 Awning gearbox 7:1 Treuil 7:1	ARG7:1A	Pz		25
	Supporti cassonetto tcl/venezia Support box tcl / venezia allum. Supports coffre tcl/venezia	TCL0A015	Cp		10
	Tappi cassonetto tcl Caps for box tcl/venezia Bouchons coffre tcl	TCL0025A	Cp		5
	Innesto superiore per guida tcl gamma Cassonetto tondo Upper clutch for tcl gamma guide Round cassette Embrayage supérieur pour guide de tcl gamma Cas ronde	TCLZ-021	Cp		5
	Supporto soffitto x cass quadro Celing support for squared box Support de plafond pour panneau carré	TCLZ-014	Pz		5
	Invito per zip Zip invitation Invitation Zip	TCLZ-050	Pz		5
	Tappo perno quadro tcl omega Ø 70 Square pin cap tcl omega Ø 70 Bouchon carré tcl omega Ø 70	TCL0-044	Pz		5
	Tappo con foro tcl omega Ø 70 Cap with hole tcl omega Ø 70 Casquette avec trou tcl omega Ø 70	TCL0-043	Pz		5
	Adattatore motore tcl omega Ø 70 Tcl omega engine adapter Ø 70 Adaptateur de moteur tcl omega Ø 70	TCL0-045	Pz		5

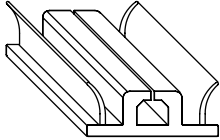
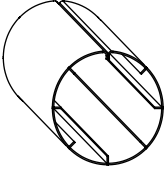
Disegno Figure Dessin	Descrizione Description Description	Codice Article Code Code Article	U.M. Unit	Prezzo unitario Unit price Prix unitaire	Conf. std. Std. pack Cf. std
	Innesto superiore per guida tcl Cassonetto quadro Upper clutch for tcl Square box Embrayage supérieur pour tcl Boîte carrée	TCLZ-025	Cp		5
	Piedino per guida tcl gamma Leg for guide tcl gamma Pied pour guide de tcl gamma	TCLZ-035	Cp		5
	Tappi terminale tcl gamma Caps terminal tcl gamma Embouts tcl gamma	TCLZ-034	Cp		5
	Tappi cassonetto quadro Square box caps Capsules carrées	TCL0025AGAM	Cp		5
	Carrucola gamma Pulley gamma Poulie gamme	TCL0027AGAM	Pz		5
	Fermacorda gamma Rope stropper gamma Bouchon de gamme	TCL0028AGAM	Pz		5
	Tappo \varnothing 70 con perno quadro 13x25 Plug with square pin 13x25 \varnothing 70 Embout \varnothing 70 avec axe carré 13x25	TAPPQ70-13x25	Pz		80
	Tappo con foro \varnothing 70 Plug \varnothing 70 with hole \varnothing 14 Embout avec trou \varnothing 70	TAPF70	Pz		200
	Piastrina con perno 14x40 Plate with pin 14x40 Plaquette avec axe 14x40	PCP00001	Pz		100
	Puleggia tcl gamma Pulley tcl gamma Poulie TCL gamma	PUL0A00GAM	Pz		10
	Molla terminale tcl gamma Spring terminal profile tcl gamma Ressort terminal tcl gamma	TCLMOL	Pz		5

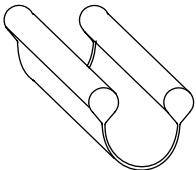
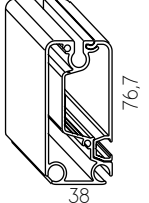
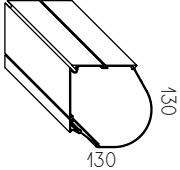
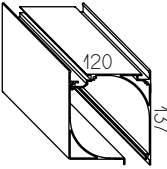
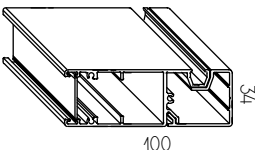
Disegno Figure Design	Descrizione Description Description		Codice Article Code Code Article	U.M. Unit	Prezzo unitario Unit price Prix unitaire	Conf. std. Std. pack Cf. std
	Spazzolino 5mm Brush 3mm Brosse 3mm		TCL-018	MI		1000
	Cordino Rope cordon		GIO.CORDA	MI		250
	Slim per guida Slim for guide Slim pour conduire	Cm 500 Cm 700	TCL5A007 TCL7A007	MI		7
	Spessore per tubo zip ml.3 Thickness for zip ml. 3 Épaisseur pour le tube zip ml.3		TCL0026AGAM	Pz		5
	Asta di manovra verniciata Crank handle Manivelle		AST0A100 AST0A120 AST0A150 AST0A180 AST0A200 AST0A200 AST0A250 AST0A300	Pz		10
	Guarnizione a palloncino per Terminale Gasket for terminal profile tcl Joint de ballon pour terminal		TCL0023	MI		50
	Terminale tcl gamma Terminal tcl gamma Barre de charge tcl delta 1819gr/ml	Cm 700	TCL7A004GAM	Pz		10
	Cassonetto di protezione Box of protection Coffre de protection 2339gr/ml	Cm 400 Cm 500 Cm 700	TCL4A003 TCL5A003 TCL7A003	Pz		10
	Cassonetto di protezione quadro Square protection box Coffre de protection carrée 2339gr/ml	Cm 400 Cm 500 Cm 700	TCL4A003GAM TCL5A003GAM TCL7A003GAM	Pz		10
	Guida completa tcl gamma Complete guide tcl gamma Guide tcl delta 1641gr/ml	Cm 500	TCL5A00GAM	Pz		10

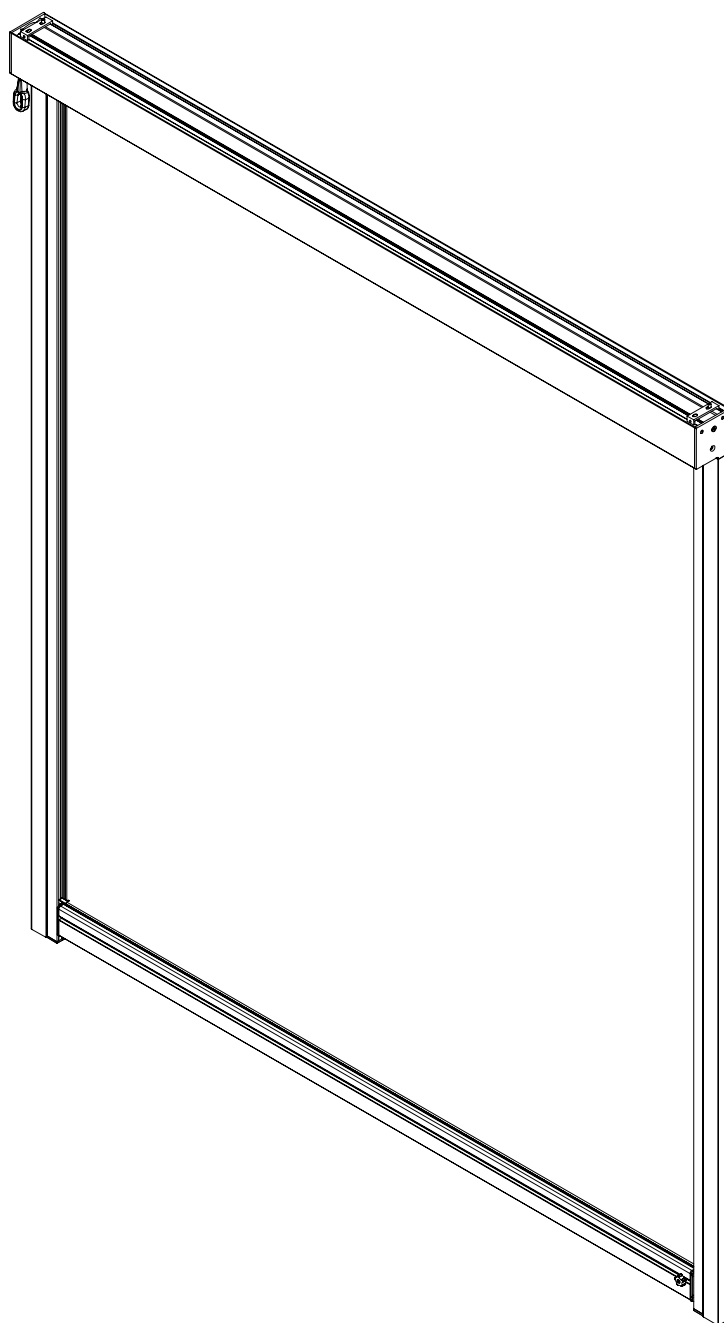

Colori di serie / Standard color / Couleurs standard



Ral
Bianco
9010

Ral
Avorio
1013



Ral
Grigio
7035

Ral
Marrone
8017

Ral
Corten

Ral
Antracite

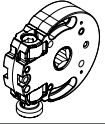
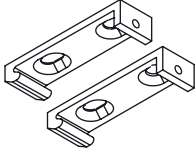
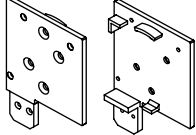
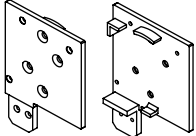
Altri colori / Another colors / Autres couleurs +20%

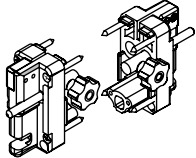
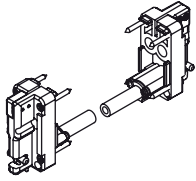
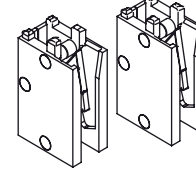
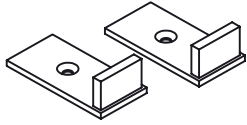
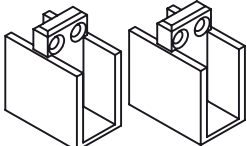
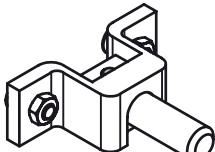
Disegno Figure Design	Descrizione Description Description	Codice Article Code Code Article	U.M. Unit	Prezzo unitario Unit price Prix unitaire	Conf. std. Std. pack Cf. std
	Arganello 10:1 Awning gearbox 7:1 Treuil 7:1	ARG10:1CAL	Pz		10
	Supporti cassonetto tcl omega Support box tcl omega Supports coffre tcl omega	TCLO-003	Cp		10
	Tappi cassonetto tcl Caps for box tcl Bouchons coffre tcl	TCLO-030	Cp		5
	Tappi cassonetto tcl Caps for box tcl Bouchons coffre tcl	TCLO-032	Cp		5
	Guarnizione terminale Terminal profile gasket Joint terminal	TCL0013	MI		50
	Tappi terminale tcl manuale Caps manual terminal tcl Embouts manuels tcl	TCLO-031	Cp		5
	Tappi terminale tcl automatica Caps terminal tcl Embouts tcl	TCLO-032	Cp		5
	Piedino per guida tcl omega automatica Foot for tcl automatic guide omega Pied pour guide automatique tcl Omega	TCLO-033	Cp		5
	Piedino per guida tcl omega manuale Leg for guide tcl omega manuale Pied pour guide de tcl omega manuale	TCLO-023	Cp		5
	Piedino per guida tcl omega manuale Leg for guide tcl omega manuale Pied pour guide de tcl omega manuale	TCLO-015	Cp		5
	Perno estraibile tcl omega Removable pin tcl omega Goupille amovible tcl omega	TCLO-029	Pz		5

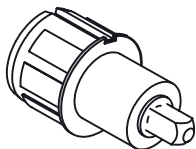
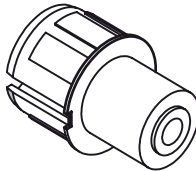
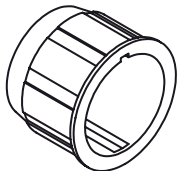
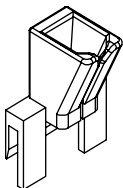
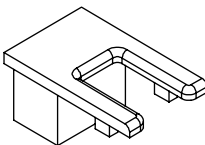
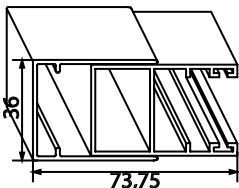
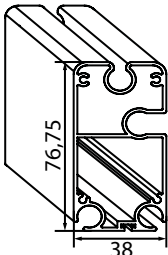
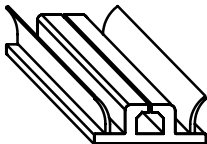
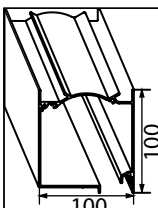
Disegno Figure Dessign	Descrizione Description Description		Codice Article Code Code Article	U.M. Unit	Prezzo unitario Unit price Prix unitaire	Conf. std. Std. pack Cf. std
	Tappo perno quadro tcl omega Ø 70 Square pin cap tcl omega Ø 70 Bouchon carré tcl omega Ø 70		TCLO-044	Pz		5
	Tappo con foro tcl omega Ø 70 Cap with hole tcl omega Ø 70 Casquette avec trou tcl omega Ø 70		TCLO-043	Pz		5
	Adattatore motore tcl omega Ø 70 Tcl omega engine adapter Ø 70 Adaptateur de moteur tcl omega Ø 70		TCLO-045	Pz		5
	Invito per zip Zip invitation Invitation Zip		TCLZ-050	Pz		5
	Inserto superiore guida Upper guide insert Insert de guidage supérieur		TCLO-042	Pz		5
	Guida telescopica Telescopic guide Guide télescopique	1285gr/ml	Cm 500 TCLO-037	Pz		7
	Terminale tcl Terminal tcl Barre de charge tcl	1045gr/ml	Cm 400 TCL4A002 Cm 500 TCL5A002 Cm 700 TCL7A002	Pz		10
	Slim per guida Slim for guide Slim pour conduire		Cm 500 TCL5A007 Cm 700 TCL7A007	Pz		7
	Cassonetto di protezione quadro Square protection box Coffre de protection carrée	2237gr/ml	Cm 400 TCLO4A001 Cm 500 TCLO5A001 Cm 700 TCLO7A001	Pz		10

Disegno Figure Design	Descrizione Description Description		Codice Article Code Code Article	U.M. Unit	Prezzo unitario Unit price Prix unitaire	Conf. std. Std. pack Cf. std
-----------------------------	---	--	--	--------------	--	------------------------------------

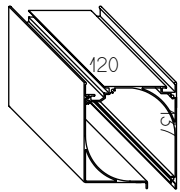

Cassonetto di protezione quadro
Square protection box
Coffre de protection carrée

2339gr/ml

Cm 400 TCL4A003GAM
Cm 500 TCL5A003GAM
Cm 700 TCL7A003GAM

Pz

10

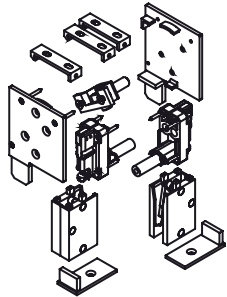

KIT TCL Omega cassonetto 10 x 10 automatica
KIT TCL Omega 10 x 10 automatic box
KIT TCL Omega 10 x 10 boîte automatique

TCLOA

Pz

5

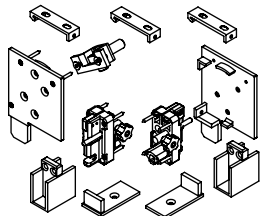

KIT TCL Omega cassonetto 10 x 10 manuale
KIT TCL Omega box 10 x 10 manual
KIT TCL Omega 10 x 10 boîte manuel

TCLOM

Pz

5

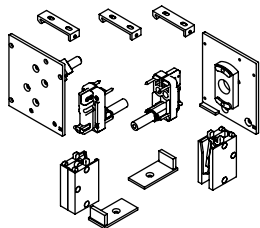

KIT TCL Omega cassonetto 12 x 12 manuale
KIT TCL Omega box 12 x 12 manual
KIT TCL Omega 12 x 12 boîte manuel

TCLO12A

Pz

5

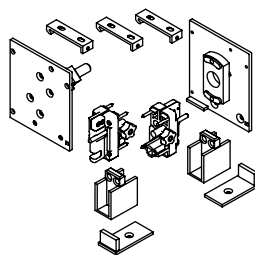

KIT TCL Omega cassonetto 12 x 12 manuale
KIT TCL Omega box 12 x 12 manual
KIT TCL Omega 12 x 12 boîte manuel

TCLO12M

Pz

5

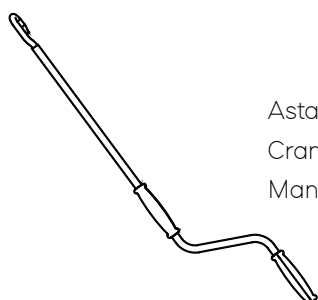

Asta di manovra verniciata
Crank handle
Manivelle

Cm 35 AST0A100
Cm 50 AST0A120
Cm 70 AST0A150
Cm 90 AST0A180
Cm 120 AST0A200
Cm 140 AST0A220
Cm 250 AST0A250
Cm 300 AST0A300

Pz

10

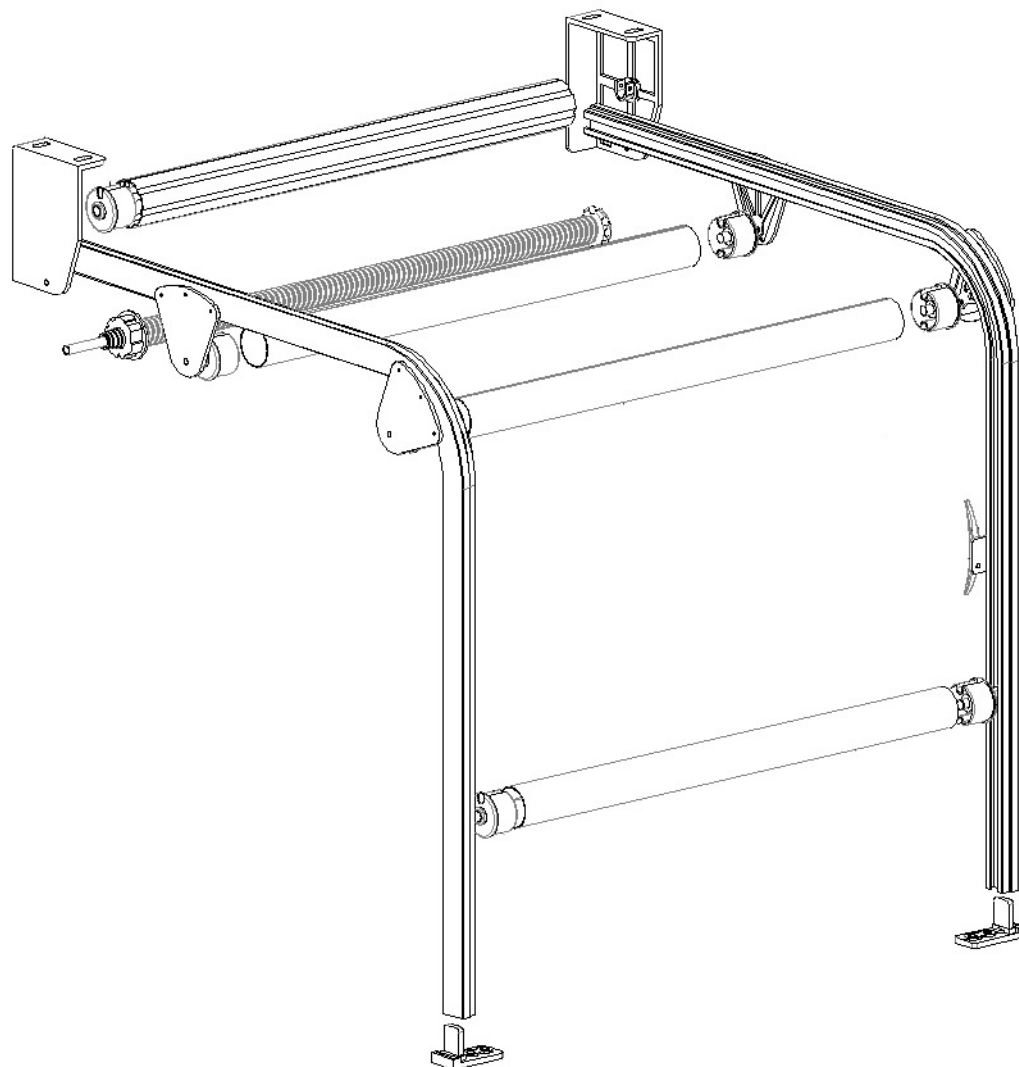



Colori di serie / Standard color / Couleurs standard



Ral Bianco 9010	Ral Verde 6005	Ral Avorio 1013	Ral Marrone 8017	Ral Grigio 7035
-----------------------	----------------------	-----------------------	------------------------	-----------------------

Ral Antracite	Ral Bronzo	Ral Nero opaco 9005
------------------	---------------	---------------------------

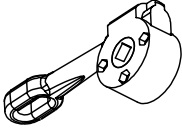
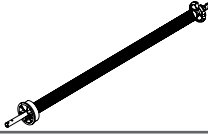
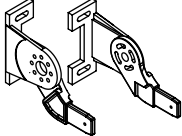
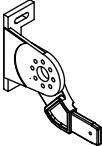
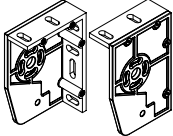
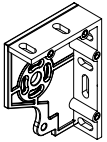
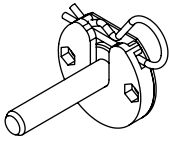
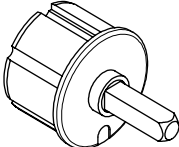
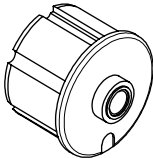
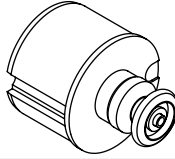
Altri colori / Another colors / Autres couleurs +20%

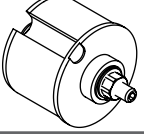
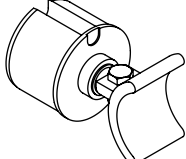
Disegno Figure Design	Descrizione Description Description	Codice Article Code Code Article	U.M. Unit	Prezzo unitario Unit price Prix unitaire	Conf. std. Std. pack Cf. std
	Arganello 11:1 Awning gearbox 11:1 Treuril 11:1	ARGM11A	Pz		25
	Molla assemblata ø 70	Cm 120 MOLLA120/70			
	Spring assembled rod empty ø 70	Cm 140 MOLLA140/70	Pz		10
	Ressort assemblé ø 70	Cm 180 MOLLA180/70			
	Staffe p/s regolabili in alluminio Adjustable bracket tmt wall / ceiling Allum Supports mur/plafond réglables en aluminium.	TMT0A019	Cp		10
	Staffa p/s accoppiata regolabile in Alluminio Adjustable bracket tmt wall / ceiling Coupled Support mur/plafond uni réglable en aluminium	TMT0A020	Pz		10
	Staffa tmt universale nuda Bracket simple universal tmt Support tmt universel simple	TMT0A025	Cp		10
	Staffa nuda accoppiata tranciata Bracket simple coupled allum. Support simple uni troncé	TMT0A027	Pz		10
	Piastrina in nylon con perno estraibile Plate nylon with removable pin Plaquette en nylon avec axe extraible	TNRM-040	Pz		100
	Tappo ø 70 con perno quadro 13x48 Plug with square pin 13x48 ø 70 Embout ø 70 avec axe carré 13x48	TAPPQ70-13x48	Pz		80
	Tappo con foro ø 70 Plug ø 70 with hole ø 14 Embout ø 70 avec trou ø 14	TAPF70	Pz		200
	Calotta scorrevole ø 60 Plug sliding ø 60 Embout coulissant ø 60	Zincata	TAPSCORZINCA	Pz	100
		Inox	TAPSCORINOXA		
	Calotta rompitratta ø 60 (Fisso) con perno Plug windbreak ø 60 (Fixed) with pin Embout brise-vent ø 60 (Fixe) avec axe	Zincata	TAPFRAZIN60A	Pz	100
		Inox	TAPFRINOX60ZA		
	Calotta perno filettato ø 60 Plug threaded pin ø 60 Embout axe fileté ø 60	Zincata	TMT000011A	Pz	100
		Inox	TMT000012A		
	Cravatta perno e tappo ø 60 Per traverse frangivento Cap and pin dia60 (tie) windbreak Support axe e embout ø 60 Pour brise-vent	TMT0009A	Pz		50

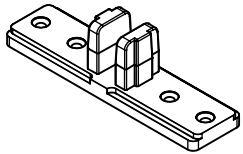
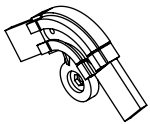
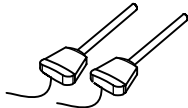
Disegno Figure	Descrizione Description		Codice Article Code	U.M. Unit	Prezzo unitario Unit price €	Conf. std. Std. pack
	Cravatta in nylon stretta Tie close nylon		TMT0A002	Pz		100
	Attache en nylon serré Cravatta in nylon larga Tie large nylon Attache en nylon large		TMT0A005			
	Piedino singolo in alluminio Leg single allum. Pied simple en aluminium		TMT0A006	Pz		100
	Piedino doppio in alluminio Led double allum. Pied double en aluminium		TMT0A012	Pz		50
	Bitta avvolgifune in alluminio Bollard winder Taquet en aluminium		TMT0A001	Pz		50
	Triangolo (fazzoletto) Triangle allum. Tmt Triangle tmt		TMT0A003	Pz		50
	Triangolo accoppiato (fazzoletto doppio) Triangle coupled allum. Tmt Triangle uni tmt		TMT0A004	Pz		50
	Tacchetti in nylon 1 foro Nylon studs 1 hole Block en nylon 1 trou		TACFORO	Pz		100
	Curva snodata in alluminio Curve adjustable tmt Courbe réglable en aluminium		TMT0A015	Pz		10
	Fermo guida Stopper for guide tmt Arrêt guide	Zincata Inox	TMT00007D SG00015D	Pz		50
	Carrello scorrevole doppio Sliding trolley side double Charriot coulissant double		SCORLAT	Pz		10
	Supporto centrale per tmt con bullone e dado Support central for tmt with Bolt	Molla	TMT0A022	Pz		10
	Support central pour tmt avec boulon et écrou	Arganello	TMT0A023			
	Treccia mm. 10 Braid mm. 10 Corde mm. 10		TMT00008	MI		200

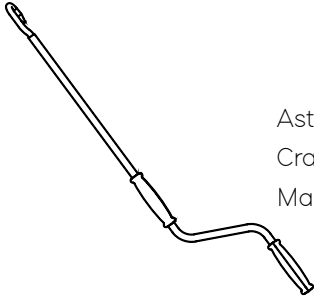
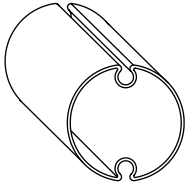
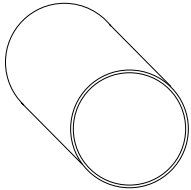
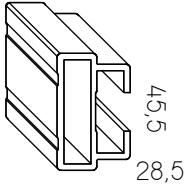
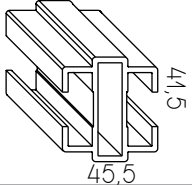
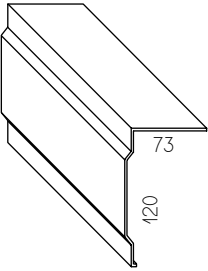
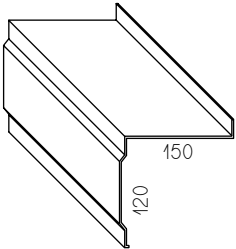
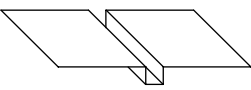
Disegno Figure	Descrizione Description	Codice Article Code	U.M. Unit	Prezzo unitario Unit price €	Conf. std. Std. pack
	Asta di manovra verniciata Crank handle Manivelle	Cm 35	AST0A100	Pz	10
		Cm 50	AST0A120		
		Cm 70	AST0A150		
		Cm 90	AST0A180		
		Cm 120	AST0A200		
		Cm 140	AST0A220		
		Cm 250	AST0A250		
	Terminale tmt Ø 60 2 Ogiva Terminal profile Ø 60 With 2 ogive Barre de charge tmt ø 60 2 Trous 959gr/ml	Cm 400	TMT4A037	Pz	10
		Cm 500	TMT5A037		
		Cm 600	TMT6A037		
		Cm 700	TMT7A037		
	Frangivento liscio ø 60 Windbreak smooth ø 60 Brise-vent lisse ø 60 782gr/ml	Cm 400	TMT4A038	Pz	10
		Cm 500	TMT5A038		
		Cm 600	TMT6A038		
		Cm 700	TMT7A038		
	Guida singola tmt Guide single tmt Guide simple tmt 1054gr/ml	Cm 400	TMT4A016	Pz	10
		Cm 500	TMT5A016		
		Cm 600	TMT6A016		
		Cm 700	TMT7A016		
	Guida doppia tmt Guide double tmt Guide double tmt 1054gr/ml	Cm 400	TMT4A035	Pz	10
		Cm 500	TMT5A035		
		Cm 600	TMT6A035		
		Cm 700	TMT7A035		
	Tettino di protezione a soffitto Canopy of protection for ceiling Auvent de protection plafond 1134gr/ml	Cm 300	TMT3A018	Pz	10
		Cm 400	TMT4A018		
		Cm 700	TMT7A018		
	Tettino di protezione a parete Canopy of protection for wall Auvent de protection mural 1675gr/ml	Cm 400	TMT4A015	Pz	10
		Cm 500	TMT5A015		
		Cm 600	TMT6A015		
		Cm 700	TMT7A015		
	Tettino centrale Canopy central Auvent central	Cm 400	TMT4A039	Pz	10
		Cm 500	TMT5A039		
		Cm 600	TMT6A039		

TMT PLUS



TMT PLUS P/S

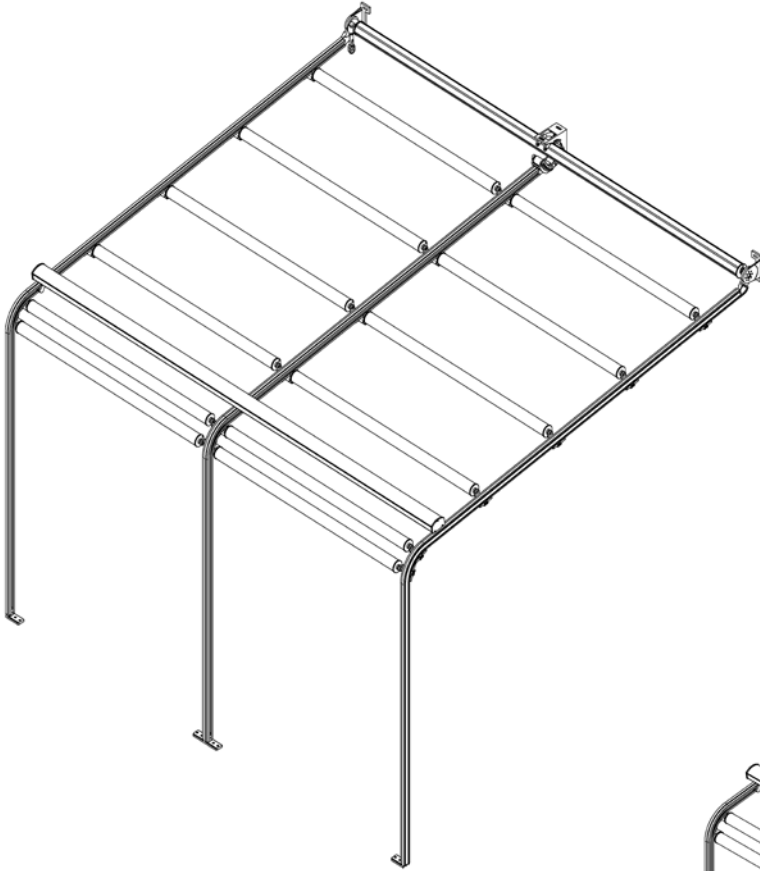

TMT PLUS B/Q



Colori di serie / Standard color / Couleurs standard



Ral
Bianco
9010





Ral
Avorio
1013

Ral
Grigio
7035

Ral
Bronzo

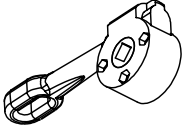
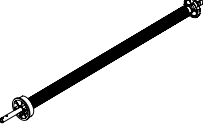
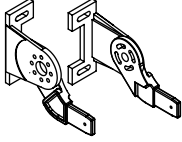
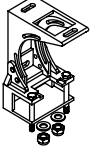
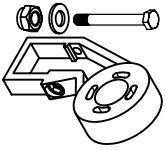
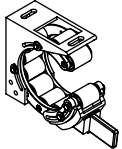
Ral
Antracite

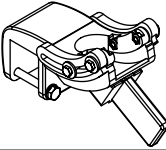
Altri colori / Another colors / Autres couleurs +20%

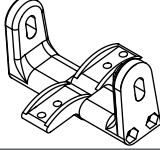
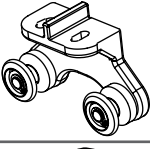
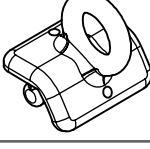
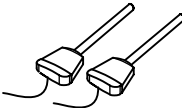
Disegno Figure Design	Descrizione Description Description		Codice Article Code Code Article	U.M. Unit	Prezzo unitario Unit price Prix unitaire	Conf. std. Std. pack Cf. std
	Arganello 11:1 Awning gearbox 11:1 Treuril 11:1		ARGM11A	Pz		25
	Molla assemblata ø 70 Spring assembled rod empty ø 70 Ressort assemblé ø 70	Cm 120 Cm 140 Cm 180	MOLLA120/70 MOLLA140/70 MOLLA180/70	Pz		10
	Staffe p/s regolabili in alluminio Adjustable bracket tmt wall / ceiling Allum. Supports réglables en aluminium		TMT0A019	Cp		10
	Supporti tmt plus P/S - B/Q con bulloneria Supports tmt plus P/S - B/Q with bolts and nuts Support mur/plafond garden et tmt plus sur barre carrée avec boulons	Zincata Inox	SG00012ZA SG00012A	Pz		10
	Supporto avvolgitore su b/q Support for winder for square bar Support enrouleur pour garden sur barre carrée		SG00007	Cp		10
	Supporto compensatore tmt plus Balance support tmt plus Compensateur tmt plus		TMTP-009A	Pz		5
	Supporto compensatore tmt plus su b/q Balance support for tmt plus on Squared bar Compensateur tmt plus b/q		TMTP-010A	Pz		5
	Supporto guida con attacco barra quadra Support for guide mount square bar Support guide avec attache barre carrée		TMTP-011A	Pz		5
	Supporto frangivento Support windbreak tmt plus Support brise-vent		TMTP-020A	Pz		20
	Supporto frangivento doppio Support windbreak double tmt plus Double support brise-vent		TMTP-019A	Pz		10
	Carrello tmt plus Trolley tmt plus Chariots tmt plus		TMTP-016A	Pz		10
	Occhiolo tmt plus Eyelet tmt plus Attache tmt plus		TMTP018-A	Pz		10
	Fermo guida Stopper for guide tmt Arrêt guide tmt	Zincata Inox	TMT00007D SG00015D	Pz		50

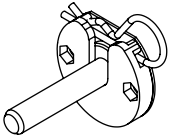
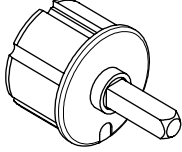
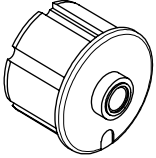
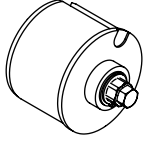
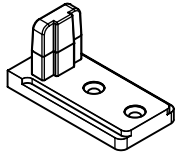
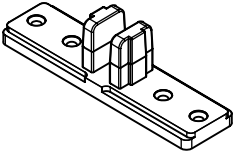
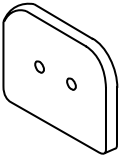
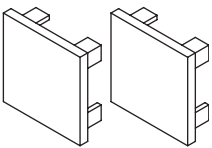
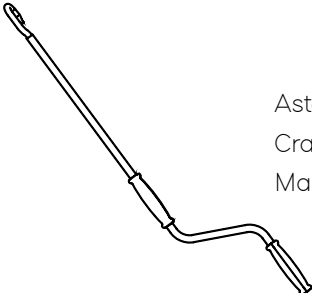
Disegno Figure Dessign	Descrizione Description Description	Codice Article Code Code Article	U.M. Unit	Prezzo unitario Unit price Prix unitaire	Conf. std. Std. pack Cf. std
	Piastrina in nylon con perno estraibile Plate nylon with removable pin Plaquette en nylon avec axe extraible	TNRM-040	Pz		100
	Tappo ø 70 con perno quadro 13x55 Plug with square pin 13x55 ø 70 Embout ø 70 avec axe carré 13x40	TAPPQ70-13x55	Pz		80
	Tappo con foro ø 70 Plug ø 70 with hole ø 14 Embout ø 70 avec trou ø 14	TAPF70	Pz		200
	Tappo frangivento tmt plus ø 60 Plug windbreak tmt plus ø 60 Embout brise-vent tmt plus ø 60	Zincata TAPFRAZIN60A	Pz		200
	Piedino singolo in alluminio Leg single allum. Pied simple en aluminium	TMT0A006	Pz		100
	Piedino doppio in alluminio Led double allum. Double pied en aluminium	TMT0A012	Pz		50
	Tappi terminale con viti Plug for terminal profile with Screws Bouchons barre de charge avec vis	OPEN-160	Cp		50
	Tappi in nylon per barra quadra Nylon caps for square bar Bouchons en nylon pour barre carrée	BQC00024A	Cp		50
	Asta di manovra verniciata Crank handle Manivelle	Cm 35 Cm 50 Cm 70 Cm 90 Cm 120 Cm 140 Cm 250 Cm 300	AST0A100 AST0A120 AST0A150 AST0A180 AST0A200 AST0A220 AST0A250 AST0A300	Pz	10

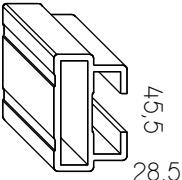
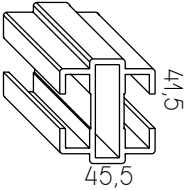
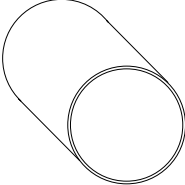
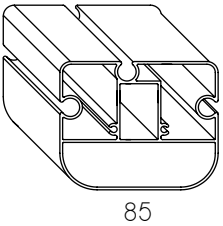
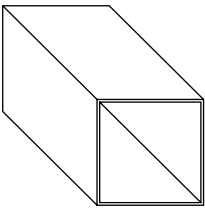
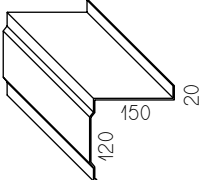
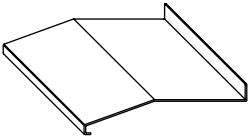
Disegno Figure Design	Descrizione Description Description		Codice Article Code Code Article	U.M. Unit	Prezzo unitario Unit price Prix unitaire	Conf. std. Std. pack Cf. std
	Guida singola tmt	Cm 400	TMT4A016	Pz		10
	Guide single tmt	Cm 500	TMT5A016			
	Guide simple tmt	Cm 600	TMT6A016			
	1054gr/ml	Cm 700	TMT7A016			
	Guida doppia tmt	Cm 400	TMT4A035	Pz		10
	Guide double tmt	Cm 500	TMT5A035			
	Guide double tmt	Cm 600	TMT6A035			
	1054gr/ml	Cm 700	TMT7A035			
	Frangivento liscio ø 60	Cm 400	TMT4A038	Pz		10
	Windbreak smooth ø 60	Cm 500	TMT5A038			
	Brise-vent lisse ø 60	Cm 600	TMT6A038			
	782gr/ml	Cm 700	TMT7A038			
	Terminale tmt plus	Cm 400	M1554A003	Pz		10
	Terminal profile tmt plus	Cm 500	M1555A003			
	Barre de charge tmt plus	Cm 600	M1556A003			
	2376gr/ml	Cm 700	M1557A003			
	Barra quadra 40x40x2 in ferro Zincata e verniciata	Cm 400	BQC4A001	Pz		10
	Square bar 40x40x2 iron zinc Painted	Cm 500	BQC5A001			
	Barre carrée 40x40x2 en fer galvanisé et laqué	Cm 600	BQC6A001			
	2393gr/ml	Cm 700	BQC7A001			
	Tettino di protezione a parete	Cm 400	TMT4A015	Pz		10
	Canopy of protection for wall	Cm 500	TMT5A015			
	Auvent de protection mural	Cm 600	TMT6A015			
	1675gr/ml	Cm 700	TMT7A015			
	Tettino in alluminio piegato	Cm 400	SG4A016	Pz		10
	Roof allum. Bent	Cm 500	SG5A016			
	Auvent en aluminium plié	Cm 600	SG6A016			
		Cm 700	SG7A016			

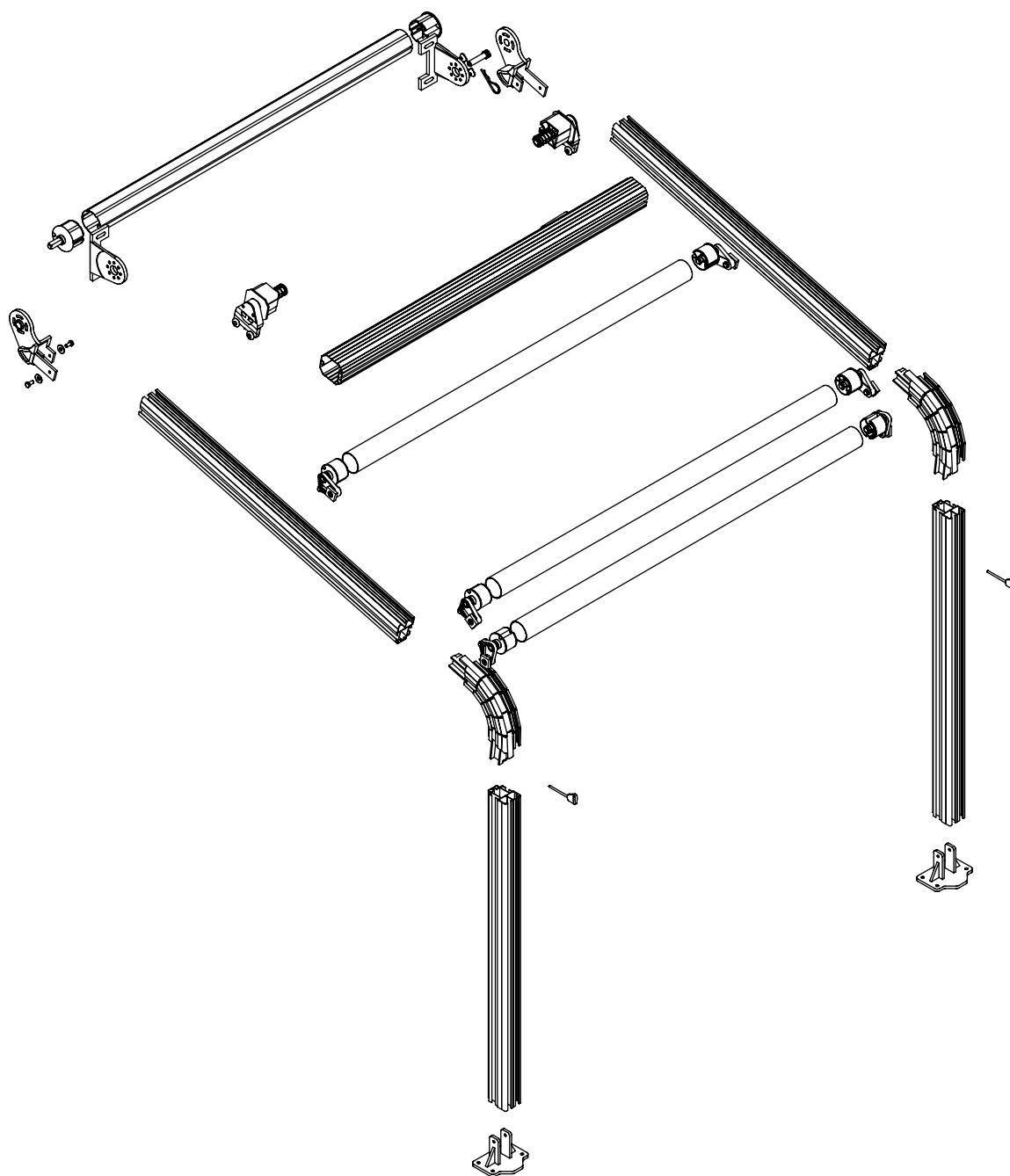

Colori di serie / Standard color / Couleurs standard







Ral
Bianco
9010

Ral
Avorio
1013

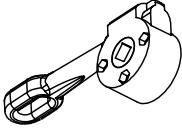
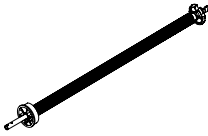
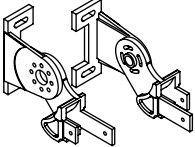
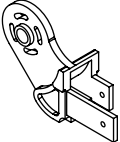
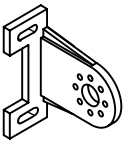
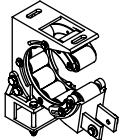
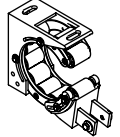
Ral
Grigio
7035

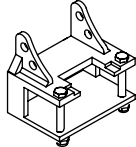
Altri colori / Another colors / Autres couleurs +20%

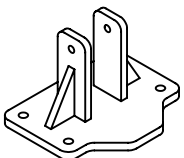
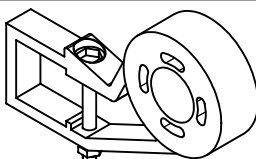
Disegno Figure Design	Descrizione Description Description		Codice Article Code Code Article	U.M. Unit	Prezzo unitario Unit price Prix unitaire	Conf. std. Std. pack Cf. std
	Arganello 11:1 Awning gearbox 11:1 Treuil 11:1		ARG11:1A	Pz		25
	Molla assemblata ø 70 Spring assembled rod empty ø 70 Ressort assemblé ø 70	Cm 120 Cm 140 Cm 180	MOLLA120/70 MOLLA140/70 MOLLA180/70	Pz		10
	Staffe universali garden con bulloneria Bracket universal sg with Bolt stainless Supports universels garden avec boulons	Inox	SG0A010	Cp		20
	Supporto guida garden con bulloni Inox Garden guide support with stainless steel bolts Support de guide garden avec bullon. inox	Dx Sx	SG0A020 SG0A021	Pz		10
	Supporto p/s garden Support wall/ceiling garden Support mur/plafond garden		SG0A017	Pz		10
	Supporto compensatore garden su b/q Support winder garden for square bar Support compensateur garden sur barre carrée		SG04015A	Pz		5
	Supporto compensatore garden ps Support winder garden wall/ceiling Support compensateur garden p/s		SG04016A	Pz		5
	Supporti tmt plus P/S - B/Q con bulloneria Supports tmt plus P/S - B/Q with bolts and nuts Supports mur/plafond garden et tmt plus sur barre carrée avec boulons	Inox	SG00012A	Pz		10
	Inserto per supporto b/q Insert for support square bar sg Insert pour support barre carrée garden	Inox	SG00013A	Pz		20
	Curva garden Curve garden Courbe garden		SG0A012	Cp		10
	Piedino garden Leg garden Pied garden		SG0A005	Pz		20
	Supporto avvolgitore su b/q Support for winder for square bar Support enrouleur pour garden sur barre carrée		SG00007	Cp		10

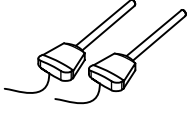
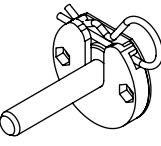
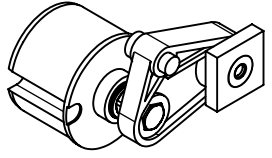
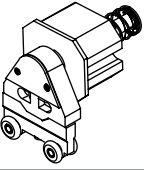
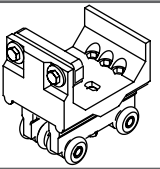
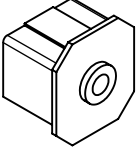
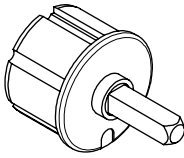
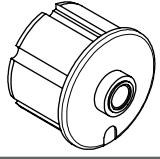
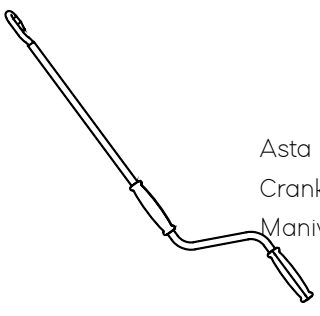
Disegno Figure Dessign	Descrizione Description Description		Codice Article Code Code Article	U.M. Unit	Prezzo unitario Unit price Prix unitaire	Conf. std. Std. pack Cf. std
	Fermo guida	Zincata	TMTP00007D	Pz		50
	Stopper for guide tmt	Inox	SG00015D			
	Piastrina in nylon con perno estraibile Plate nylon with removable pin Plaquette en nylon avec axe extraible		TNRM-040	Pz		100
	Tappo frangivento garden inox Caps for windbreak with pin Stainless Embout brise-vent garden inox		SG00008A	Cp		50
	Carrello scorrevole garden Sliding trolley sg with accessories Stainless Chariot coulissant garden		SG0D001	Pz		20
	Carrello scorrevole centrale Garden Sliding trolley central sg with Accessories stainless Chariot central coulissant garden		SG0D002	Pz		10
	Tappo terminale garden Terminal plug Bouchon barre de charge garden		SG00011	Cp		100
	Tappo ø 70 con perno quadro 13x55 Plug with square pin 13x55 ø 70 Embout ø 70 avec axe carré 13x55		TAPPQ70-13x55	Pz		80
	Tappo con foro ø 70 Plug ø 70 with hole ø 14 Embout ø 70 avec trou ø 14		TAPF70	Pz		200
	Asta di manovra verniciata	Cm 35	AST0A100	Pz		10
	Crank handle	Cm 50	AST0A120			
	Manivelle	Cm 70	AST0A150			
		Cm 90	AST0A180			
		Cm 120	AST0A200			
		Cm 140	AST0A220			
		Cm 250	AST0A250			
	Cm 300	AST0A300				

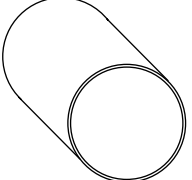
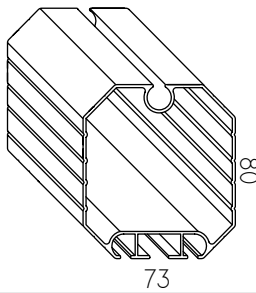
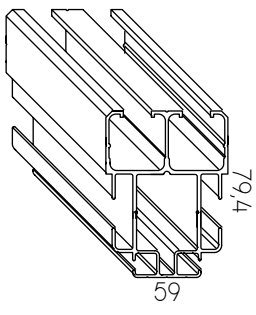
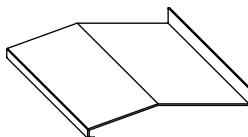
Disegno Figure Design	Descrizione Description Description		Codice Article Code Code Article	U.M. Unit	Prezzo unitario Unit price Prix unitaire	Conf. std. Std. pack Cf. std
	Frangivento liscio ø 60	Cm 400	TMT4A035	Pz		10
	Windbreak smooth ø 60	Cm 500	TMT5A035			
	Brise-vent lisse ø 60	Cm 600	TMT6A035			
	782gr/ml	Cm 700	TMT7A035			
	Terminale garden	Cm 400	SG4A013	Pz		10
	Terminal profile garden	Cm 500	SG5A013			
	Barre de charge garden	Cm 600	SG6A013			
	1364gr/ml	Cm 700	SG7A013			
	Guida garden	Cm 500	SG5A014	Pz		10
	Guide garden	Cm 600	SG6A014			
	Guide garden	Cm 700	SG7A014			
	1712gr/ml					
	Tettino in alluminio piegato	Cm 400	SG4A016	Pz		10
	Roof allum. Bent	Cm 500	SG5A016			
	Auvent en aluminium plié	Cm 600	SG6A016			
		Cm 700	SG7A016			

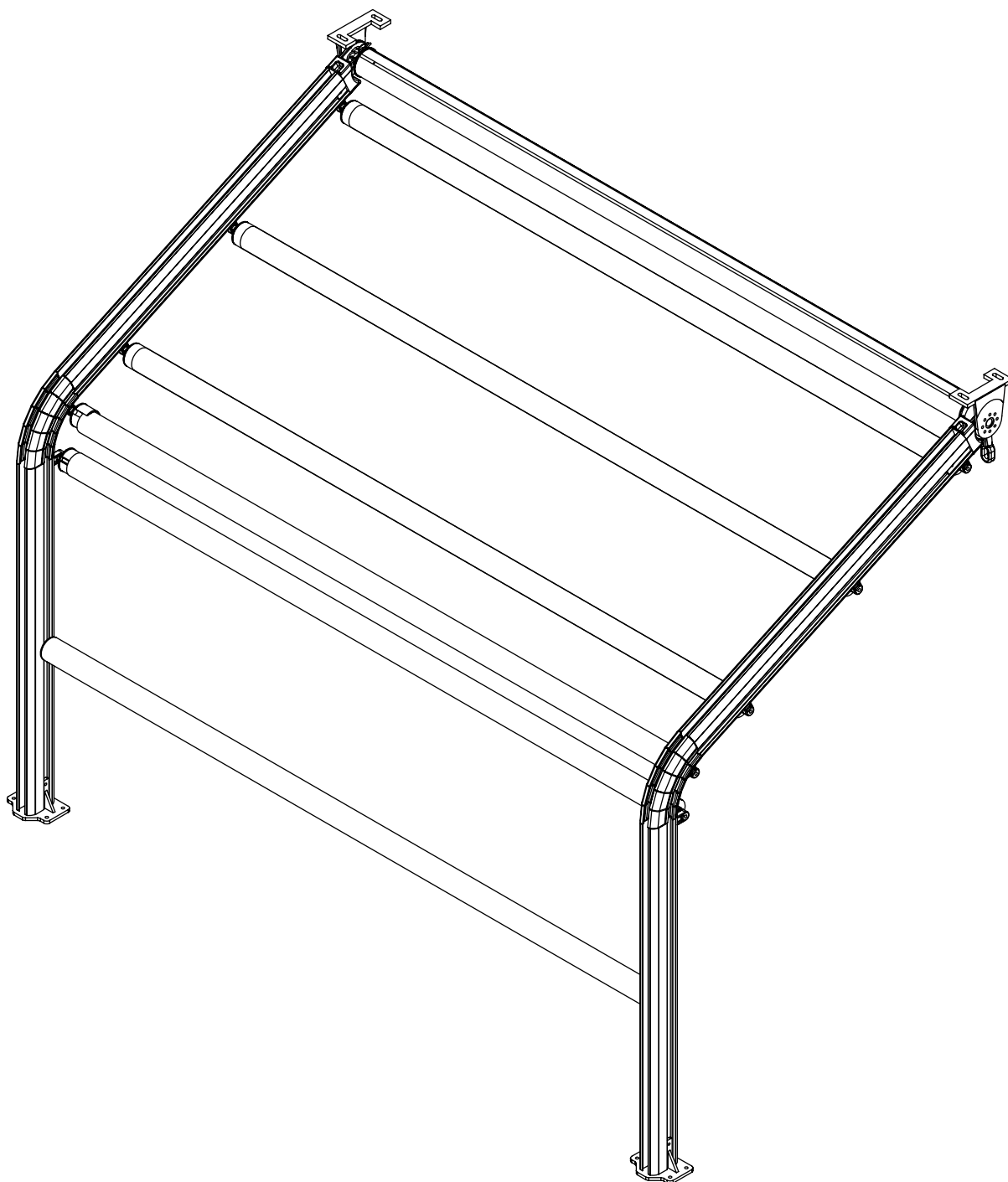

Colori di serie / Standard color / Couleurs standard



Ral
Bianco
9010

Ral
Avorio
1013

Altri colori / Another colors / Autres couleurs +20%

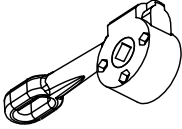
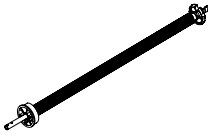
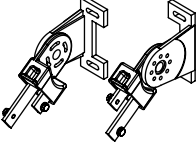
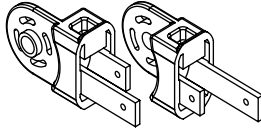
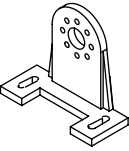
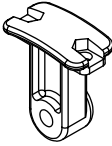
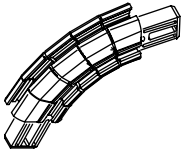
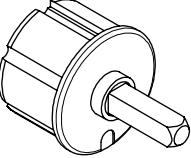
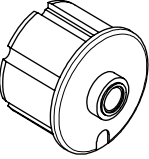
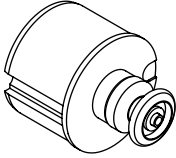
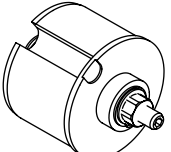
Disegno Figure Design	Descrizione Description Description		Codice Article Code Code Article	U.M. Unit	Prezzo unitario Unit price Prix unitaire	Conf. std. Std. pack Cf. std
	Arganello 11:1 Awning gearbox 11:1		ARG11:1A	Pz		25
	Molla assemblata ø 70 Spring assembled rod empty ø 70	Cm 120 Cm 140 Cm 180	MOLLA120/70 MOLLA140/70 MOLLA180/70	Pz		10
	Staffe universali garden con bulloneria Bracket universal sg with Bolt stainless Supports universels garden avec boulons	Inox	GRN2-006	Cp		20
	Supporto guida garden dx con bullon. Inox Support guide right with stainless bolt Support de guide garden droit avec bullon. inox Supporto guida garden sx con bullon. Inox Support guide left with stainless bolt Support de guide garden gauche avec Bullon. inox		GRN2-011 GRN2-010	Pz		10
	Supporto p/s garden Support wall/ceiling garden Support mur/plafond garden		SG0A017	Pz		10
	Supporto frangivento con bullon. Support windbreak with bolts Support brise-vent		GRN2-013	Pz		100
	Curva new garden Curve new garden Courbe new garden		GRN2-007	Pz		10
	Tappo ø 70 con perno quadro 13x55 Plug with square pin 13x55 ø 70 Embout ø 70 avec axe carré 13x55		TAPPQ70-13x55	Pz		80
	Tappo con foro ø 70 Plug ø 70 with hole ø 14 Embout ø 70 avec trou ø 14		TAPF70	Pz		200
	Calotta scorrevole ø 60 Plug sliding ø 60 Embout coulissant ø 60	Inox	TAPSCORINOXA	Pz		100
	Calotta perno filettato ø 60 Plug threaded pin ø 60 Embout axe fileté ø 60	Inox	TMT00012A	Pz		100

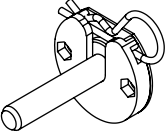
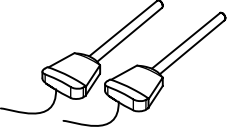
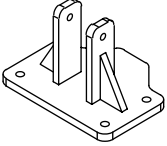
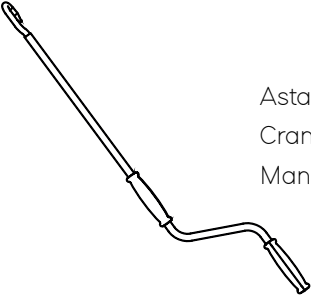
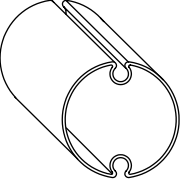
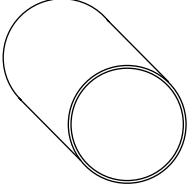
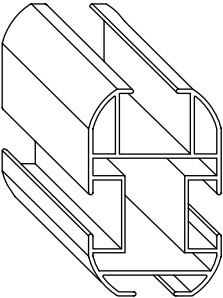
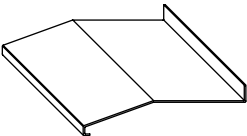
Disegno Figure Design	Descrizione Description Description		Codice Article Code Code Article	U.M. Unit	Prezzo unitario Unit price Prix unitaire	Conf. std. Std. pack Cf. std
	Piastrina in nylon con perno estraibile Plate nylon with removable pin Plaquette en nylon avec axe extraible		PES0005	Pz		100
	Fermo guida Stopper for guide tmt Arrêt guide	Inox	SG00015D	Pz		50
	Piedino new garden Leg new garden Pied garden		GRN2-012	Pz		20
	Asta di manovra verniciata Crank handle Manivelle	Cm 35	AST0A100	Pz		10
		Cm 50	AST0A120			
		Cm 70	AST0A150			
		Cm 90	AST0A180			
		Cm 120	AST0A200			
		Cm 140	AST0A200			
		Cm 250	AST0A250			
Cm 300	AST0A300					
	Terminale tmt Ø 60 2 Ogiva Terminal profile Ø 60 With 2 ogive Barre de charge tmt ø 60 2 Trous 959gr/ml	Cm 400	TMT4A037	Pz		10
		Cm 500	TMT5A037			
		Cm 600	TMT6A037			
		Cm 700	TMT7A037			
	Frangivento liscio ø 60 Windbreak smooth ø 60 Brise-vent lisse ø 60 782gr/ml	Cm 400	TMT4A038	Pz		10
		Cm 500	TMT5A038			
		Cm 600	TMT6A038			
		Cm 700	TMT7A038			
	Guida new garden Guide new garden Guide new garden 2259gr/ml	Cm 500	GRN5A001	Pz		10
		Cm 600	GRN6A001			
		Cm 700	GRN7A001			
	Tettino in alluminio piegato Roof allum. Bent Auvent en aluminium plié	Cm 400	SG4A016	Pz		10
		Cm 500	SG5A016			
		Cm 600	SG6A016			
		Cm 700	SG7A016			

Note

A large rectangular area with horizontal dotted lines, intended for writing notes.



60

70

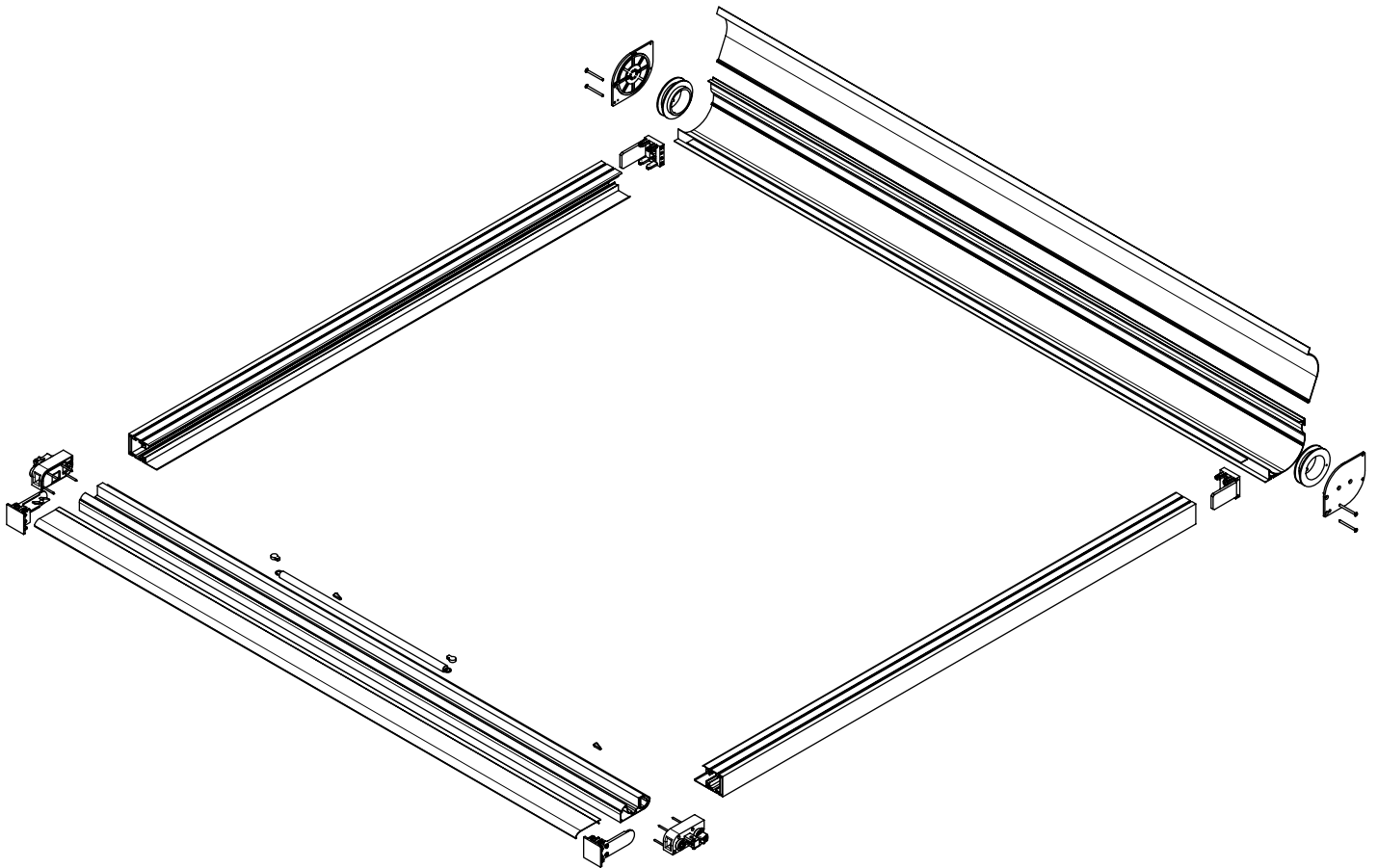

Colori di serie / Standard color / Couleurs standard





Ral
Bianco
9010

Ral
Avorio
1013

Ral
Grigio
7035

Ral
Marrone
8017

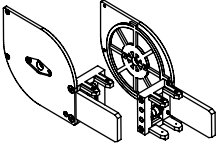
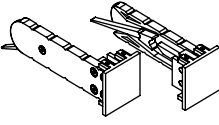
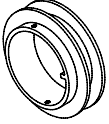
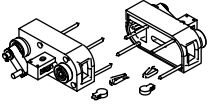
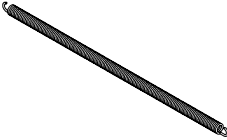
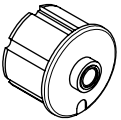
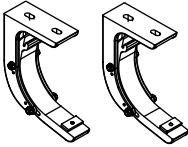
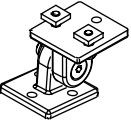
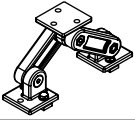
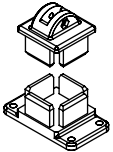
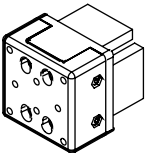
Altri colori / Another colors / Autres couleurs +20%

Disegno Figure Dessign	Descrizione Description Description		Codice Article Code Code Article	U.M. Unit	Prezzo unitario Unit price Prix unitaire	Conf. std. Std. pack Cf. std
	Tappi cassonetto raffaello con inserti superiori guida Plugs box insert media guide Bouchons coffre raffaello avec inserts supérieurs guide		RAFF0A001	Cp		5
	Tappi inferiori guida con aggancio Plugs bottom guide with hook Bouchons inférieurs avec Accrochage		RAFF0A002	Cp		5
	Puleggia ø 85 Pulley ø 85 Poulie ø 85		RAFF0A004	Cp		5
	Kit registrazione cavetto con tappi Terminale Kit recorder with cable stoppers Kit enregistrement cable avec Bouchons barre de charge		RAFF0A005	Pz		5
	Molla terminale raffaello cm.94 Spring terminal profile raffaello Cm.94 Ressort barre de charge raffaello 94 cm	Cm 74	RAFF0A006	Pz		5
	Tappo Ø 85 Con foro Ø 14 Plug Ø 85 with hole Ø 14 Embout ø 85 avec trou		TAPF85	Pz		80
	Supporti cassonetto p/s Supports box wall/ceiling Supports coffre mur/plafond		RAFF0A008	Cp		5
	Piedino per guida (fisso) leg for guide(fixed) Pied pour guide (fixe)		RAFF0A010	Pz		5
	Piedino regolabile per guida Leg for guide adjustable Pied réglable pour guide		OPEN-060A	Pz		5
	Piedino inferiore e innesto superiore Gamba Lower feet and upper grip Leg Pied inférieur et support supérieur jambe		RAFF0A009	Cp		5
	Innesto traversa Cross-member coupling Couplage de traverse		E095-109	Cp		10
	Cordino Rope Cordon		GIO.CORDA	MI		250

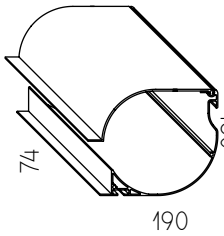
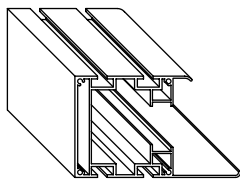
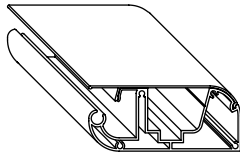
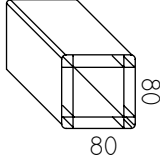
Disegno Figure Dessign	Descrizione Description Description		Codice Article Code Code Article	U.M. Unit	Prezzo unitario Unit price Prix unitaire	Conf. std. Std. pack Cf. std
	Cassonetto raffaello	Cm 400	CASSRF4A			
	Box raffaello	Cm 500	CASSRF5A	Pz		10
	Coffre raffaello	Cm 600	CASSRF6A			
	4284gr/ml					
	Guida raffaello	Cm 400	GUIRF4A			
	Guide raffaello	Cm 500	GUIRF5A	Pz		10
	Guide raffaello	Cm 600	GUIRF6A			
	2760gr/ml					
	Terminale raffaello con profilo Di chiusura	Cm 400	TERMRF4A			
	Terminal profile raffaello	Cm 500	TERMRF5A	Pz		10
	With profile of closure	Cm 600	TERMRF6A			
	Barre de charge raffaello avec profil de fermeture	3496gr/ml				
	Profilo traversa e piede 80x80	Cm 500	E0955A001			
	Profile cross 80x80			Pz		10
	Profil traverse et pied 80x80	Cm 700	E0957A001			
	3262gr/ml					

Note

A large rectangular area with horizontal dotted lines, intended for writing notes.

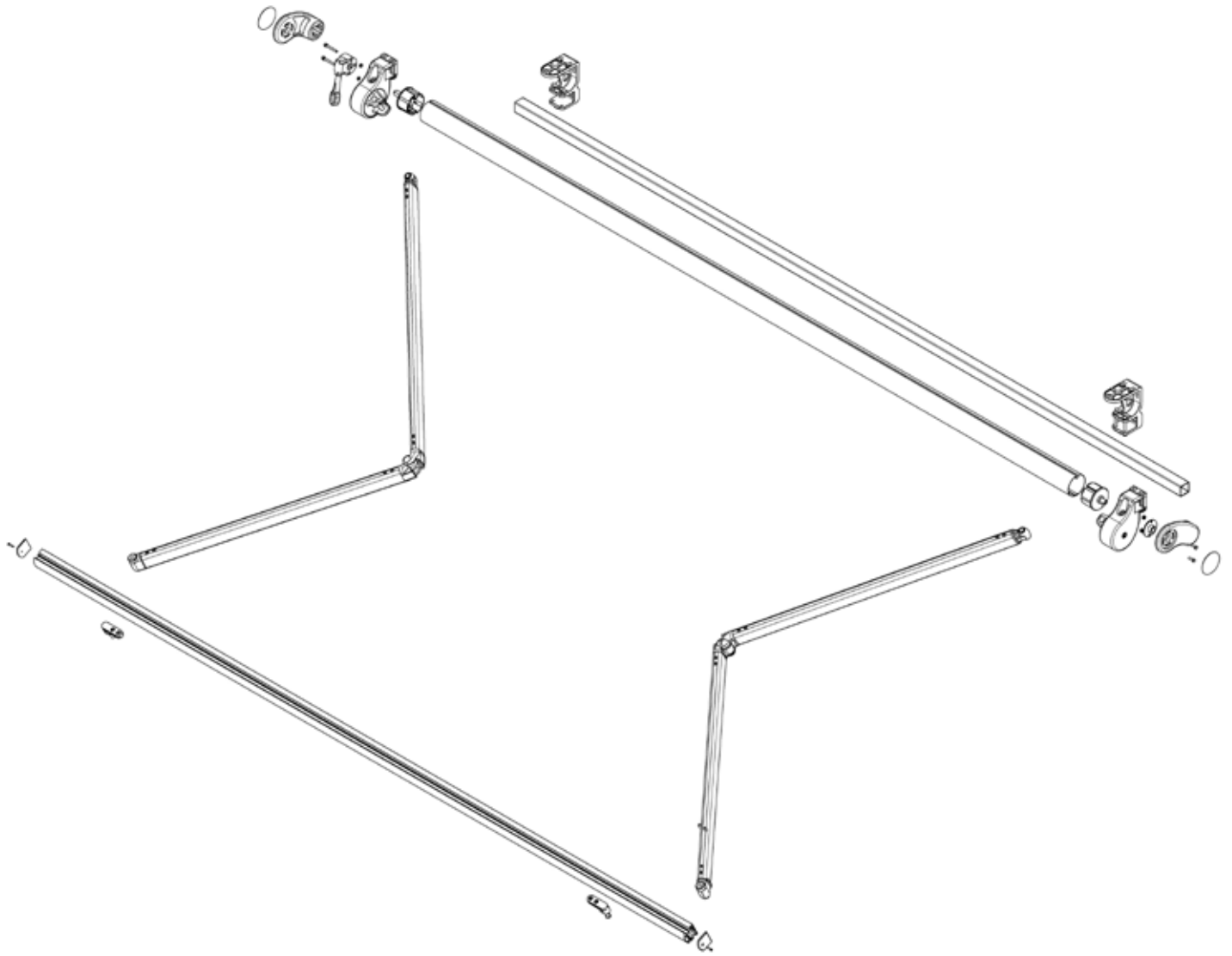

Colori di serie / Standard color / Couleurs standard



Ral Bianco 9010	Ral Avorio 1013	Ral Marrone 8017	Ral Grigio 7035
Ral Antracite	Ral Bronzo	Ral Nero opaco 9005	

Altri colori / Another colors / Autres couleurs +20%

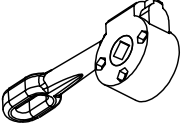
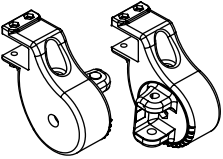
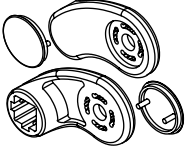
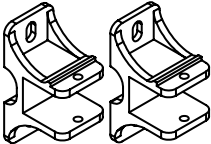
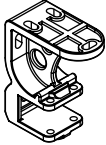
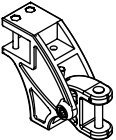
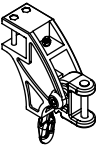
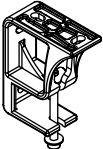
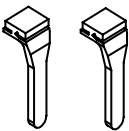
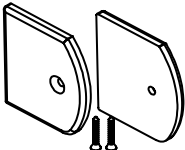
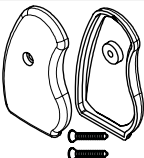
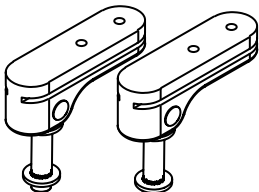
Disegno Figure Design	Descrizione Description Description	Codice Article Code Code Article	U.M. Unit	Prezzo unitario Unit price Prix unitaire	Conf. std. Std. pack Cf. std
	Arganello 11:1 Awning gearbox 11:1 Treuil 11:1	ARG11:A	Pz		25
	Supporto braccio lux c91 Support for arm lux c91 Support bras lux c91	LUX0001/90A			
	Supporto avvolgitore lux/compact Support winder b4c lux/compact Support enrouleur b4c lux/compact	LUX0002A	Cp		10
	Supporto simmetrico Support symmetrical Support symétrique	BQ40-056A	Cp		10
	Supporto universale b/q lux Support universal square bar lux Support universel barre carrée lux	LUX0003A	Cp		10
	Supporto braccio v 91 Support arm v 91 Support bras réglable v 91	SUPV91A	Cp		10
	Supporto braccio regolabile v 91r Support arm adjustable v 91r Support bras réglable v 91r	SUPV91REG-A	Cp		10
	Supporto universale barra quadra v10 Bracket universal square bar v10 Support universel barre carrée v10	SUPPS/V10A	Cp		20
	Scivolo raccoglibraccio in nylon Slide tray arms Goulotte ramasse-bras en nylon	SCIV00001A	Cp		100
	Tappi terminale 31266 con viti Caps for terminal profile with Screws Bouchons barre de charge 31266 avec vis	EUR0A025	Cp		50
	Tappi terminale alto con viti Caps for terminal profile with Screws Bouchons barre de charge 31266 avec vis	BQ40-020	Cp		50
	Scivolo snodato in alluminio Articulated slide lux Goulotte barre de charge en alum.	LUX0004A	Cp		25

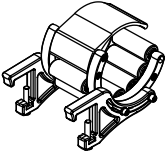
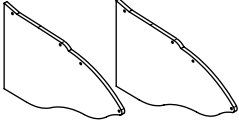
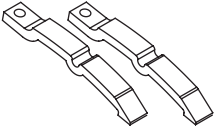
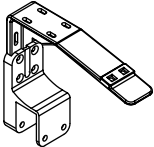
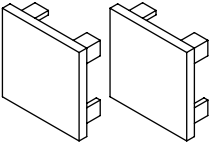
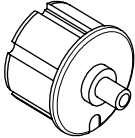
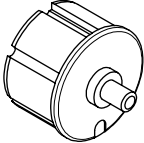
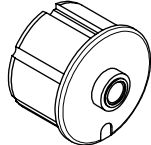
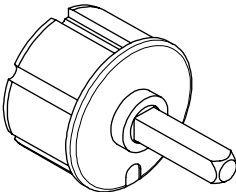
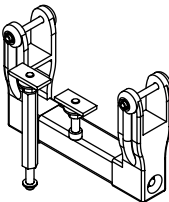
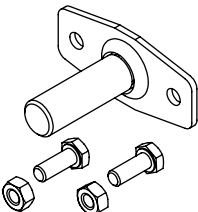
Disegno Figure Design	Descrizione Description Description	Codice Article Code Code Article	U.M. Unit	Prezzo unitario Unit price Prix unitaire	Conf. std. Std. pack Cf. std
	Supporto compensatore Balance support Support compensateur	BQC0A019	Pz		10
	Tappi in nylon per tettino estruso Caps for roof extruded nylon Bouchons en nylon pour auvent extrudé	BQA0A029	Cp		20
	Stecchette per tettino Cues for roof Branchettes pour auvent	BQA0A029	Cp		10
	Staffe intermedie regolabili per tettino Intermediate bracket for roof Square bar Supports intermediaires réglables pour auvent	BQC0A039	Pz		10
	Tappi in nylon per barra quadra Nylon caps for square bar Bouchons en nylon pour barre carrée	BQC00024A	Cp		50
	Tappo d.70 Con perno tondo 14x20 Plug with round pin dia 70 14x20 Embout ø 70 avec axe rond 14x20	TAPT70	Cp		80
	Tappo d.78 Con perno tondo 14x20 Plug with round pin dia 78 14x20 Embout ø 78 avec axe rond 14x20	TAPT78	Cp		80
	Tappo con foro Plug with hole Embout avec trou	Ø 70 TAPF70 Ø 78 TAPF78	Pz		200
	Tappo d.78 Con perno quadro Plug ø 78 with square pin Embout ø 70 avec axe carré 13x40	13x25 TAPPQ80-13x25 13x40 TAPPQ80-13x40 13x48 TAPPQ80-13x48 13x55 TAPPQ80-13x55 13x70 TAPPQ80-13x70	Pz		20
	Kit supporto bracci incrociati Kit support with cross arms Kit support bras croisés	BQC0A018	Pz		5
	PIASTRINA CON PERNO-PLATE WITH PIN-PLAQUETTE AVEC AXE Senza bulloni e dadi Without bolts and nuts Sans boulons et écrous Con bulloni e dadi With bolts and nuts Avec Boulons et écrous	13x40 PCP00001 13x75 PCP00002 13x40 PCP00003 13x75 PCP00004	Pz		100

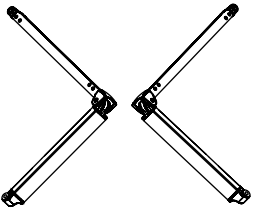
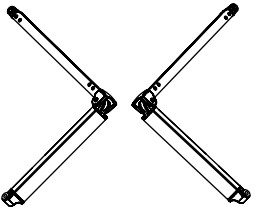
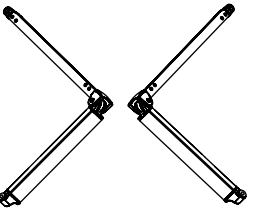
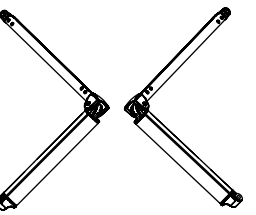
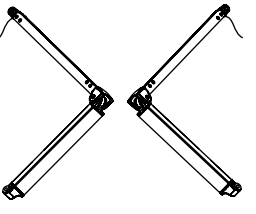
Disegno Figure Design	Descrizione Description Description	Codice Article Code Code Article	U.M. Unit	Prezzo unitario Unit price Prix unitaire	Conf. std. Std. pack Cf. std
	Bracci a catena Arms with chain Bras à chaîne	Cm 160	BRA0A160		
		Cm 185	BRA0A185		
		Cm 210	BRA0A210		
		Cm 235	BRA0A235		
		Cm 260	BRA0A260	Cp	10
		Cm 285	BRA0A285		
		Cm 310	BRA0A310		
		Cm 360	BRA0A360		
	Bracci a cavetto Arms with cable Bras à câble	Cm 160	BQCCAV0A160		
		Cm 185	BRACAV0A185		
		Cm 210	BRACAV0A210		
		Cm 235	BRACAV0A235		
		Cm 260	BRACAV0A260	Cp	10
		Cm 285	BRACAV0A285		
		Cm 310	BRACAV0A310		
		Cm 360	BRACAV0A360		
	Bracci a catena twister Arms with chain twister Bras à chaîne twister	Cm 160	TWS0A160		
		Cm 185	TWS0A185		
		Cm 210	TWS0A210		
		Cm 235	TWS0A235		
		Cm 260	TWS0A260	Cp	10
		Cm 285	TWS0A285		
		Cm 310	TWS0A310		
		Cm 360	TWS0A360		
	Bracci con cavetti in acciaio Rivestiti Arms with steel wires Coated Bras avec câble en acier recouvert	Cm 160	BRA0A160F		
		Cm 185	BRA0A185F		
		Cm 210	BRA0A210F		
		Cm 235	BRA0A235F		
		Cm 260	BRA0A260F	Cp	10
		Cm 285	BRA0A285F		
		Cm 310	BRA0A310F		
		Cm 360	BRA0A360F		
	Bracci led a catena Arms with chain Bras à chaîne	Cm 160	BQC-LED-160A		
		Cm 185	BQC-LED-185A		
		Cm 210	BQC-LED-210A		
		Cm 235	BQC-LED-235A		
		Cm 260	BQC-LED-260A	Cp	10
		Cm 285	BQC-LED-285A		
		Cm 310	BQC-LED-310A		
		Cm 360	BQC-LED-360A		
Cm 410	BQC-LED-410A				

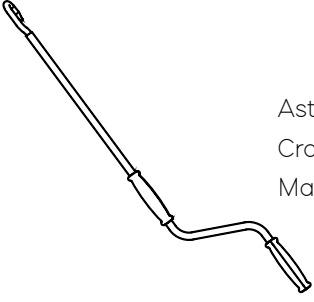
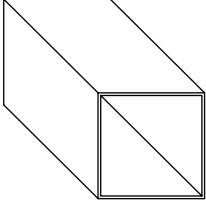
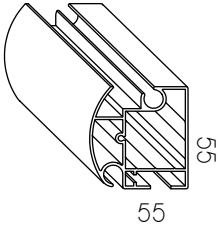
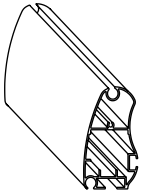
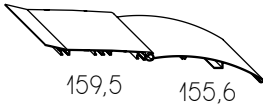
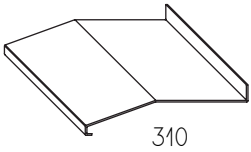
Disegno Figure Dessign	Descrizione Description Description	Codice Article Code Code Article	U.M. Unit	Prezzo unitario Unit price Prix unitaire	Conf. std. Std. pack Cf. std
	Asta di manovra verniciata Crank handle Manivelle	Cm 35	AST0A100	Pz	10
		Cm 50	AST0A120		
		Cm 70	AST0A150		
		Cm 90	AST0A180		
		Cm 120	AST0A200		
		Cm 140	AST0A200		
		Cm 250	AST0A250		
		Cm 300	AST0A300		
	Barra quadra 40x40x2 in ferro Zincata e verniciata Square bar 40x40x2 iron zinc Painted Barre carrée 40x40x2 en fer galvanisé et peint 2393gr/ml	Cm 400	BQC4A001	Pz	10
		Cm 500	BQC5A001		
		Cm 600	BQC6A001		
		Cm 700	BQC7A001		
	Terminale 31266 Terminal profile 31266 Barre de charge 31266 1276gr/ml	Cm 400	BQC4A030	Pz	10
		Cm 500	BQC5A030		
		Cm 600	BQC6A030		
		Cm 700	BQC7A030		
	Terminale alto Terminal profile Barre de charge 1494gr/ml	Cm 400	AA1550-4A	Pz	10
		Cm 500	AA1550-5A		
		Cm 600	AA1550-6A		
		Cm 700	AA1550-7A		
	Tettino estruso Roof extruded Auvent extrudé 1835gr/ml	Cm 400	BQC4A1ES	Pz	10
		Cm 500	BQC5A1ES		
		Cm 600	BQC6A1ES		
		Cm 700	BQC7A1ES		
	Tettino piegato Roof allum. Bent Auvent plié	Cm 300	BQC3A1	Pz	10
		Cm 400	BQC4A1		
		Cm 500	BQC5A1		
		Cm 600	BQC6A1		
		Cm 700	BQC7A1		

Note

A large rectangular area with horizontal dotted lines, intended for writing notes.

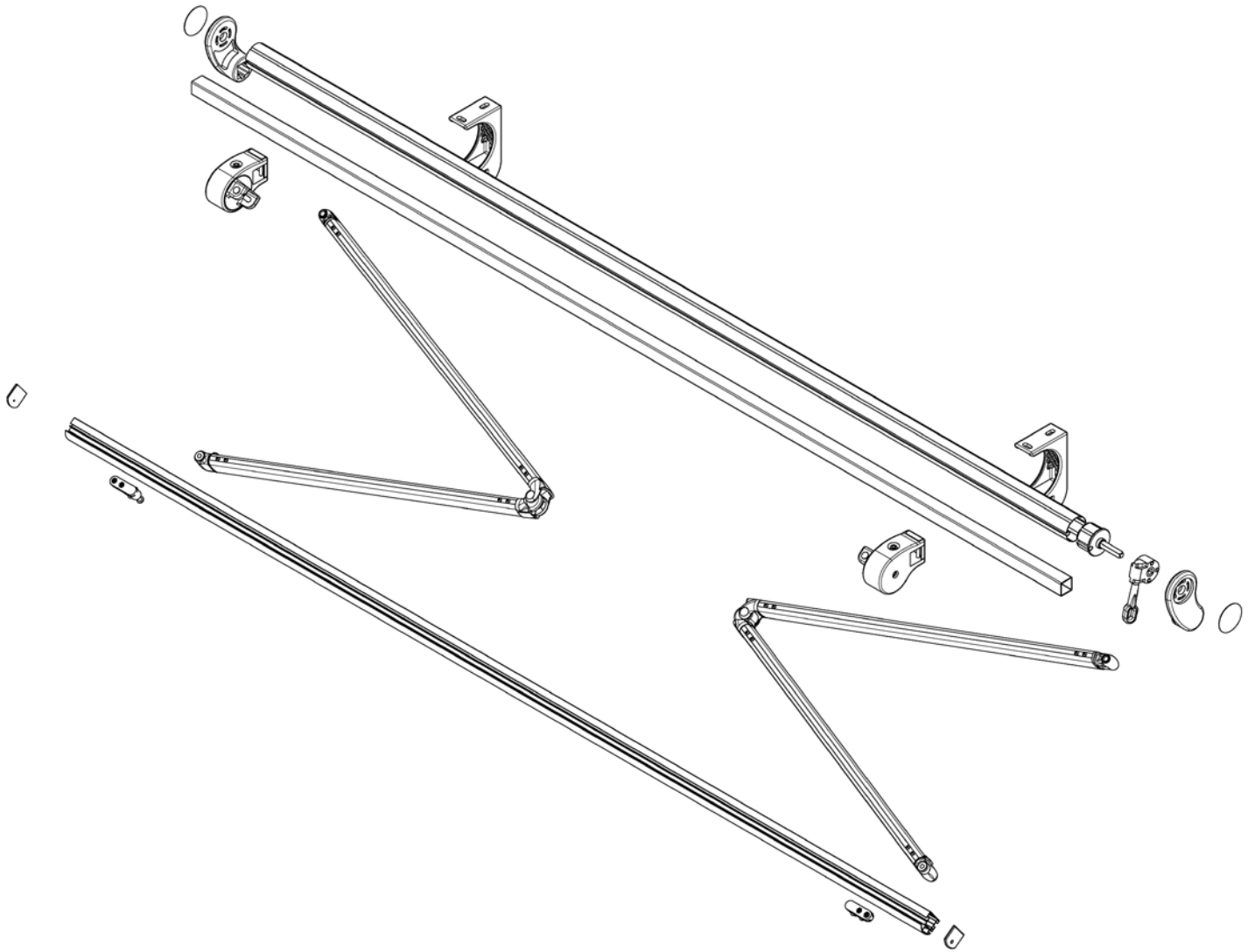

Colori di serie / Standard color / Couleurs standard



Ral Bianco 9010	Ral Verde 6005	Ral Avorio 1013	Ral Marrone 8017	Ral Grigio 7035
	Ral Antracite	Ral Bronzo	Ral Nero opaco 9005	

Altri colori / Another colors / Autres couleurs +20%

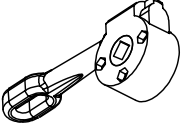
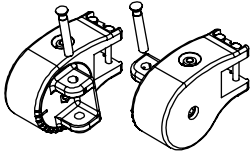
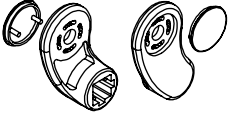
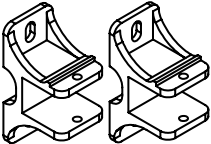
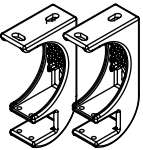
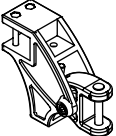
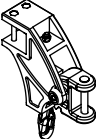
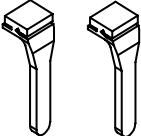
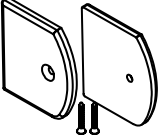
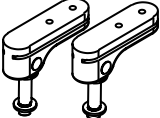
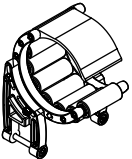
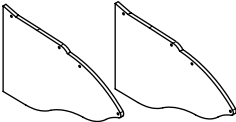
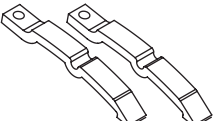
Disegno Figure Design	Descrizione Description Description	Codice Article Code Code Article	U.M. Unit	Prezzo unitario Unit price Prix unitaire	Conf. std. Std. pack Cf. std
	Arganello 11:1 Awning gearbox 11:1 Treuil 11:1	ARG11:1A	Pz		25
	Supporto braccio compact C90 Support for arm compact C90 Support bras compact c90	COMP0002/90			
	Supporto avvolgitore lux/compact Support winder b4c lux/compact Support enrouleur b4c lux/compact	LUX0002A	Cp		10
	Supporto simmetrico Support symmetrical Support symétrique	BQ40-056A	Cp		10
	Staffe parete soffitto b4c compact Bracket wall/ceiling compact Supports mur/plafond b4c compact	COMP0001	Cp		5
	Supporto braccio v 91 Support arm v 91 Support bras réglable v 91	SUPV91A	Cp		10
	Supporto braccio regolabile v 91r Support arm adjustable v 91r Support bras réglable v 91r	SUPV91REG-A	Cp		10
	Scivolo raccoglibraccio in nylon Slide tray arms Goulotte ramasse-bras en nylon	SCIV00001A	Cp		100
	Tappi terminale 31266 con viti Caps for terminal profile with Screws Bouchons barre de charge 31266 avec vis	EUR0A025	Cp		50
	Scivolo snodato in alluminio Articulated slide lux Goulotte barre de charge	LUX0004A	Cp		25
	Supporto compensatore Balance support for b4c compact Support compensateur	COMP0004A	Pz		10
	Tappi in nylon per tettino estruso Caps for roof extruded nylon Bouchons en nylon pour auvent extrudé	BQA0A029	Cp		20
	Stecchette per tettino Cues for roof Branchettes pour auvent extrudé	BQA0A029	Cp		10

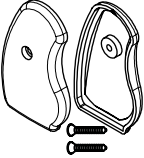
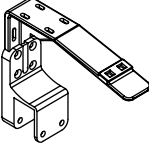
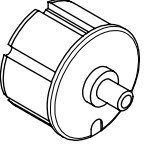
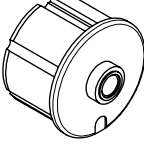
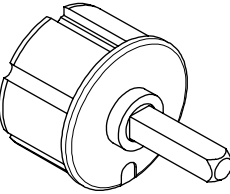
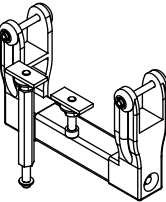
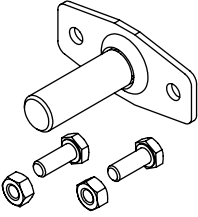
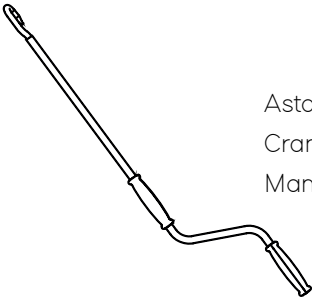
Disegno Figure Dessign	Descrizione Description Description	Codice Article Code Code Article	U.M. Unit	Prezzo unitario Unit price Prix unitaire	Conf. std. Std. pack Cf. std
	Tappi terminale alto con viti Caps for terminal profile with Screws Bouchons barre de charge avec vis	BQ40-020	Cp		50
	Staffe intermedie regolabili per tettino Intermediate bracket for roof Square bar Support intermediaire pour auvent sur barre carrée	BQC0A039	Pz		10
	Tappo perno tondo \varnothing 70 Plug with round pin \varnothing 70 Embout avec axe rond \varnothing 70	\varnothing 70	TAPPT70	Pz	80
	Tappo \varnothing 78 con perno tondo 14x20 Plug with round pin \varnothing 78 14x20 Embout avec axe rond \varnothing 78	\varnothing 78	TAPPT78		
	Tappo con foro Plug with hole Embout avec trou	\varnothing 70	TAPF70	Pz	200
		\varnothing 78	TAPF78		
	Tappo d.78 Con perno quadro Plug \varnothing 78 with square pin Embout \varnothing 78 avec axe carré	13x25	TAPPQ80-13x25	Pz	20
		13x40	TAPPQ80-13x40		
		13x48	TAPPQ80-13x48		
		13x55	TAPPQ80-13x55		
		13x70	TAPPQ80-13x70		
	Kit supporto bracci incrociati Kit support with cross arms Kit support bras croisés	BQC0A018	Pz		5
	PIASTRINA CON PERNO-PLATE WITH PIN-PLAQUETTE AVEC AXE Senza bulloni e dadi Without bolts and nuts Sans boulons et écrous	13x40	PCP00001	Pz	100
	Con bulloni e dadi With bolts and nuts Avec Boulons et écrous	13x40	PCP00003		
		13x75	PCP00002		
		13x75	PCP00004		
	Asta di manovra verniciata Crank handle Manivelle	Cm 35	AST0A100	Pz	10
		Cm 50	AST0A120		
		Cm 70	AST0A150		
		Cm 90	AST0A180		
		Cm 120	AST0A200		
		Cm 140	AST0A200		
		Cm 250	AST0A250		
Cm 300	AST0A300				

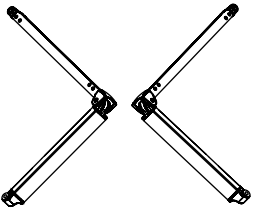
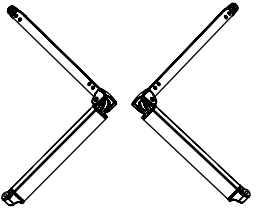
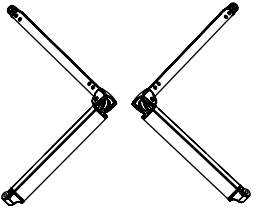
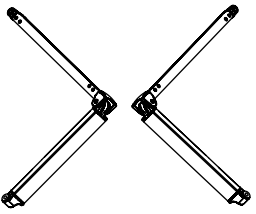
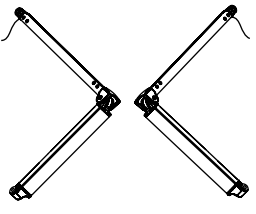
Disegno Figure Design	Descrizione Description Description	Codice Article Code Code Article	U.M. Unit	Prezzo unitario Unit price Prix unitaire	Conf. std. Std. pack Cf. std
	Bracci a catena Arms with chain Bras à chaîne	Cm 160	BRA0A160	Cp	10
		Cm 185	BRA0A185		
		Cm 210	BRA0A210		
		Cm 235	BRA0A235		
		Cm 260	BRA0A260		
		Cm 285	BRA0A285		
		Cm 310	BRA0A310		
		Cm 360	BRA0A360		
	Bracci a cavetto Arms with cable Bras à câble	Cm 160	BQCCAV0A160	Cp	10
		Cm 185	BRACAV0A185		
		Cm 210	BRACAV0A210		
		Cm 235	BRACAV0A235		
		Cm 260	BRACAV0A260		
		Cm 285	BRACAV0A285		
		Cm 310	BRACAV0A310		
		Cm 360	BRACAV0A360		
	Bracci a catena twister Arms with chain twister Bras à chaîne twister	Cm 160	TWS0A160	Cp	10
		Cm 185	TWS0A185		
		Cm 210	TWS0A210		
		Cm 235	TWS0A235		
		Cm 260	TWS0A260		
		Cm 285	TWS0A285		
		Cm 310	TWS0A310		
		Cm 360	TWS0A360		
	Bracci con cavetti in acciaio Rivestiti Arms with steel wires Coated Bras avec câble en acier recouvert	Cm 160	BRA0A160F	Cp	10
		Cm 185	BRA0A185F		
		Cm 210	BRA0A210F		
		Cm 235	BRA0A235F		
		Cm 260	BRA0A260F		
		Cm 285	BRA0A285F		
		Cm 310	BRA0A310F		
		Cm 360	BRA0A360F		
	Bracci led a catena Arms with chain Bras à chaîne	Cm 160	BQC-LED-160A	Cp	10
		Cm 185	BQC-LED-185A		
		Cm 210	BQC-LED-210A		
		Cm 235	BQC-LED-235A		
		Cm 260	BQC-LED-260A		
		Cm 285	BQC-LED-285A		
		Cm 310	BQC-LED-310A		
		Cm 360	BQC-LED-360A		
Cm 410	BQC-LED-410A				

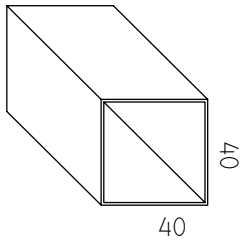
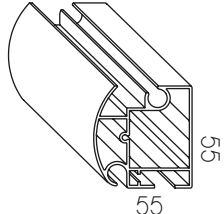
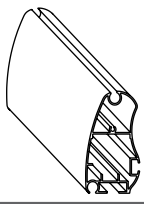
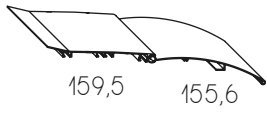
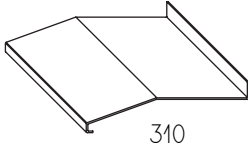
Disegno Figure Dessin	Descrizione Description Description		Codice Article Code Code Article	U.M. Unit	Prezzo unitario Unit price Prix unitaire	Conf. std. Std. pack Cf. std
	Barra quadra 40x40 in ferro Zincata e verniciata	Cm 400	BQC4A001	Pz		10
	Square bar 40x40 iron zinc Painted	Cm 500	BQC5A001			
	Barre carrée 40x40 en fer galvanisé et peint	Cm 600	BQC6A001			
		Cm 700	BQC7A001			
	Terminale 31266	Cm 400	BQC4A030	Pz		10
	Terminal profile 31266	Cm 500	BQC5A030			
	Barre de charge 31266	Cm 600	BQC6A030			
		Cm 700	BQC7A030			
	Terminale alto	Cm 400	AA1550-4A	Pz		10
	Terminal profile	Cm 500	AA1550-5A			
	Barre de charge	Cm 600	AA1550-6A			
		Cm 700	AA1550-7A			
	Tettino estruso	Cm 400	BQC4A1ES	Pz		10
	Roof extruded	Cm 500	BQC5A1ES			
	Auvent extrudé	Cm 600	BQC6A1ES			
		Cm 700	BQC7A1ES			
	Tettino piegato	Cm 300	BQC3A1	Pz		10
	Roof allum. Bent	Cm 400	BQC4A1			
	Auvent plié	Cm 500	BQC5A1			
		Cm 600	BQC6A1			
		Cm 700	BQC7A1			

ATTENZIONE

LA BQC COMPACT CASSONATA E' REALIZZATA CON GLI STESSI ACCESSORI DELLA BQC COMPACT

ATTENTION

BQC THE BOX COMPACT AND MADE WITH THE SAME ACCESSORIES BQC COMPACT

ATTENTION

LE BQC COMPACT AVEC COFFRE EST FAIT AVEC LES MÊMES ACCESSOIRES DU BQC COMPACT

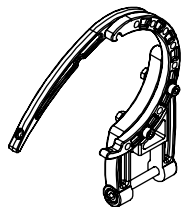

Supporto semicircolare per cassonetto compact
Support semicircular for box Compact
Support semicirculaire pour coffre Compact

COMP0005A

Pz

10

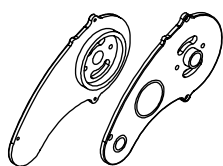

Tappi cassonetto completi di regolazione
Caps for box with adjustment bolts
Bouchons coffre complets de réglage

COMP0006A

Cp

10

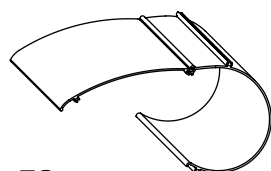

Cassonetto compact
Box compact
Coffre compact

Cm 400 CASSCMP4A

Cm 500 CASSCMP5A

Cm 600 CASSCMP6A

Cm 700 CASSCMP7A

Pz

5

Note

A large rectangular area with horizontal dotted lines, intended for writing notes.

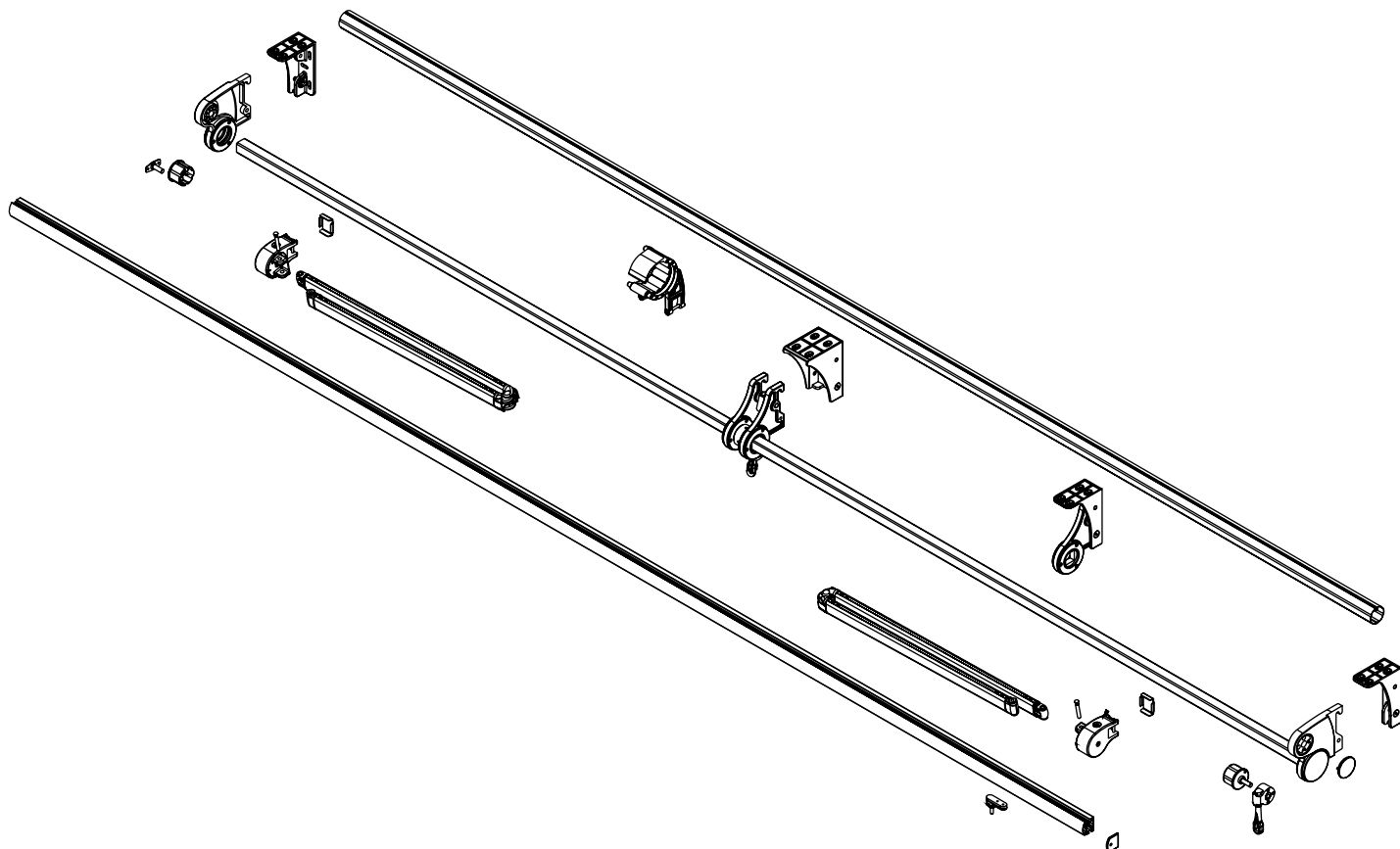



Colori di serie / Standard color / Couleurs standard

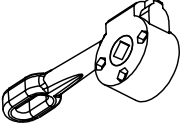
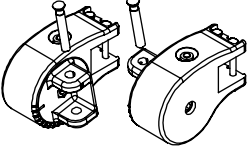
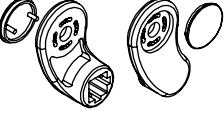
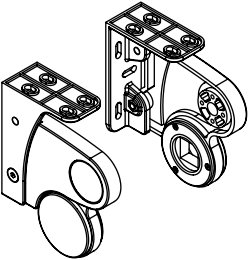
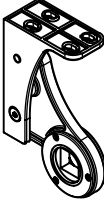

Ral Bianco 9010	Ral Verde 6005	Ral Avorio 1013	Ral Marrone 8017	Ral Grigio 7035
	Ral Antracite	Ral Bronzo	Ral Nero opaco 9005	

Altri colori / Another colors / Autres couleurs +20%

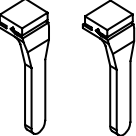
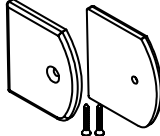
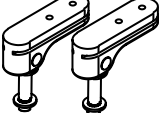
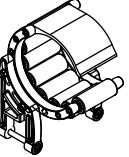
Disegno Figure Design	Descrizione Description Description	Codice Article Code Code Article	U.M. Unit	Prezzo unitario Unit price Prix unitaire	Conf. std. Std. pack Cf. std
	Arganello 11:1 Awning gearbox 11:1 Treuil 11:1	ARG11:A	Pz		25
	Supporto braccio compact C90 Support for arm compact C90 Support bras compact c90	COMP0002/90	Cp		
	Supporto avvolgitore lux/compact Support winder bqc lux/compact Support enrouleur bqc lux/compact	LUX0002A	Cp		10
	Staffe parete soffitto Bracket wall/ceiling Supports mur/plafond	SHDW-033	Cp		5
	Supporto intermedio Intermediate support Support intermédiaire	SHDW-032	Cp		10
	Supporto di regolazione Adjustment support Aide au réglage	SHDW-031	Cp		10
	Scivolo raccoglibraccio in nylon Slide tray arms Goulotte ramasse-bras en nylon	SCIV00001A	Cp		100
	Tappi terminale 31266 con viti Caps for terminal profile with Screws Bouchons barre de charge 31266 avec vis	EUR0A025	Cp		50
	Scivolo snodato in alluminio Articulated slide lux Goulotte barre de charge	LUX0004A	Cp		25
	Supporto compensatore Balance support for bqc compact Support compensateur	SHDW-027	Pz		10

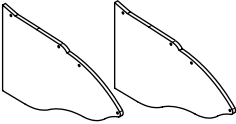
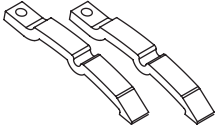
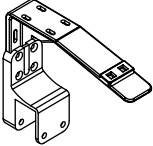
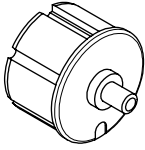
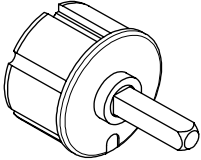
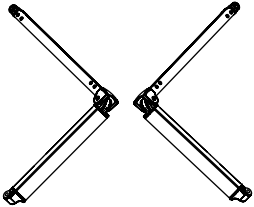
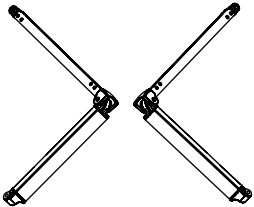
Disegno Figure Dessign	Descrizione Description Description	Codice Article Code Code Article	U.M. Unit	Prezzo unitario Unit price Prix unitaire	Conf. std. Std. pack Cf. std
	Tappi in nylon per tettino estruso Caps for roof extruded nylon Bouchons en nylon pour auvent extrudé	BQA0A029	Cp		20
	Stecchette per tettino Cues for roof Branchettes pour auvent	BQA0A029	Cp		10
	Staffe intermedie regolabili per tettino Intermediate bracket for roof Square bar Supports intermediaires réglables pour auvent	BQC0A039	Pz		10
	Tappo d.70 Con perno tondo 14x20 Plug with round pin dia 70 14x20 Embout ø 70 avec axe rond 14x20	Ø 70 TAPPT70	Pz		80
	Tappo d.78 Con perno tondo 14x20 Plug with round pin dia 78 14x20 Embout ø 78 avec axe rond 14x20	Ø 78 TAPPT78			
	Tappo perno quadro ø 70 Plug with square ø 70 Embout avec axe carré ø 70	13x48 TAPPQ70-13x48	Pz		80
	Tappo perno quadro ø 78 Plug with square ø 78 Embout avec axe carré ø 78	13x48 TAPPQ80-13x48			
	Bracci a catena Arms with chain Bras à chaîne	Cm 160 KIR0A160 Cm 185 KIR0A185 Cm 210 KIR0A210 Cm 235 KIR0A235 Cm 260 KIR0A260 Cm 285 KIR0A285 Cm 310 KIR0A310	Cp		10
	Bracci a cavetto Arms with cable Bras à câble	Cm 160 CAV0A160 Cm 185 CAV0A185 Cm 210 CAV0A210 Cm 235 CAV0A235 Cm 260 CAV0A260 Cm 285 CAV0A285 Cm 310 CAV0A310	Cp		10

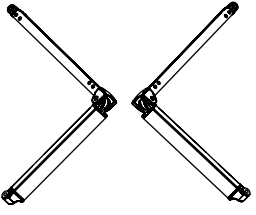
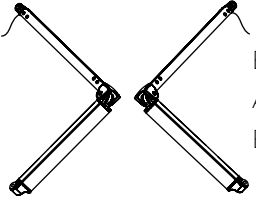
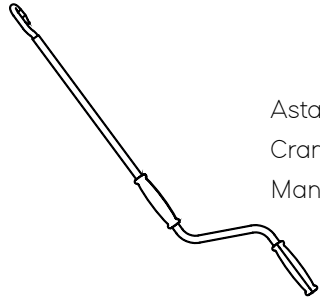
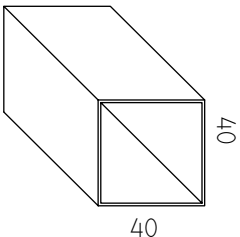
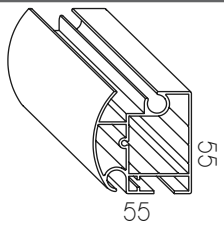
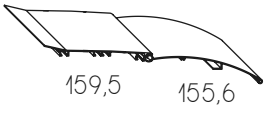
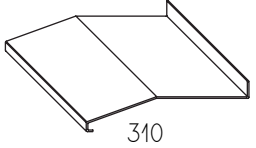
Disegno Figure Design	Descrizione Description Description	Codice Article Code Code Article	U.M. Unit	Prezzo unitario Unit price Prix unitaire	Conf. std. Std. pack Cf. std
	Bracci con cavetti in acciaio Rivestiti Arms with steel wires Couted Bras avec câble en acier recouvert	Cm 160	KIROA-160F	Cp	10
		Cm 185	KIROA-185F		
		Cm 210	KIROA-210F		
		Cm 235	KIROA-235F		
		Cm 260	KIROA-260F		
		Cm 285	KIROA-285F		
	Bracci led KIRO a catena Arms with chain Bras à chaîne	Cm 160	KIRO-LED-160A	Cp	10
		Cm 185	KIRO-LED-185A		
		Cm 210	KIRO-LED-210A		
		Cm 235	KIRO-LED-235A		
		Cm 260	KIRO-LED-260A		
		Cm 285	KIRO-LED-285A		
	Asta di manovra verniciata Crank handle Manivelle	Cm 100	AST0A100	Cp	10
		Cm 120	AST0A120		
		Cm 150	AST0A150		
		Cm 180	AST0A180		
		Cm 200	AST0A200		
		Cm 220	AST0A220		
		Cm 250	AST0A250		
Cm 300	AST0A300				
	Barra quadra 40x40 in ferro Zincata e verniciata Square bar 40x40 iron zinc Painted Barre carrée 40x40 en fer galvanisé et peint 2393gr/ml	Cm 400	BQC4A001	Pz	10
		Cm 500	BQC5A001		
		Cm 600	BQC6A001		
		Cm 700	BQC7A001		
	Terminale 31266 Terminal profile 31266 Barre de charge 31266 1276gr/ml	Cm 400	BQC4A030	Pz	10
		Cm 500	BQC5A030		
		Cm 600	BQC6A030		
		Cm 700	BQC7A030		
	Tettino estruso Roof extruded Auvent extrudé 1835gr/ml	Cm 400	BQC4A1ES	Pz	10
		Cm 500	BQC5A1ES		
		Cm 600	BQC6A1ES		
		Cm 700	BQC7A1ES		
	Tettino piegato Roof allum. Bent Auvent plié	Cm 300	BQC3A1	Pz	10
		Cm 400	BQC4A1		
		Cm 500	BQC5A1		
		Cm 600	BQC6A1		
		Cm 700	BQC7A1		

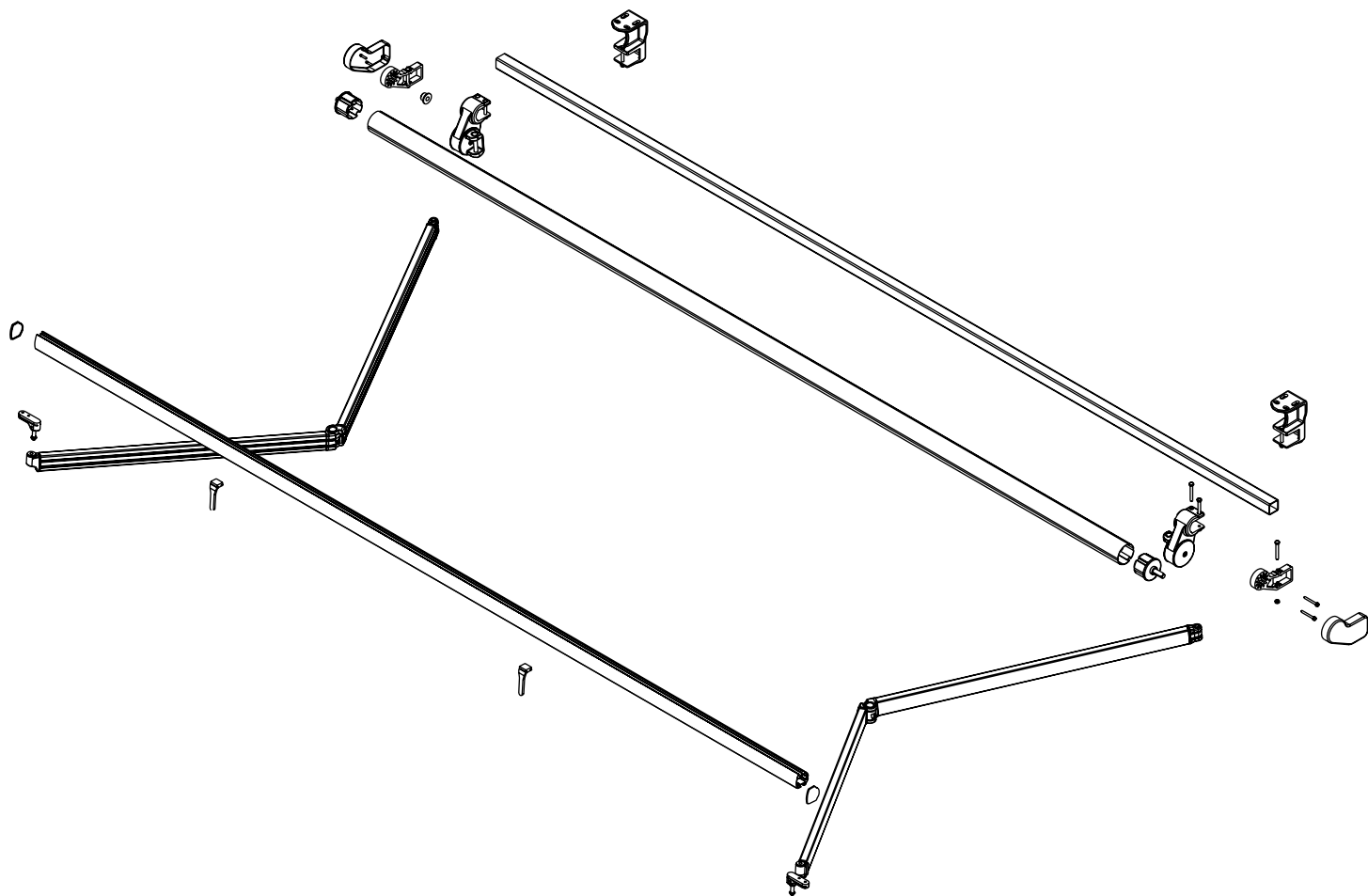

Colori di serie / Standard color / Couleurs standard



Ral Bianco 9010	Ral Verde 6005	Ral Avorio 1013	Ral Marrone 8017	Ral Grigio 7035
	Ral Antracite	Ral Bronzo	Ral Nero opaco 9005	

Disegno Figure Design	Descrizione Description Description	Codice Article Code Code Article	U.M. Unit	Prezzo unitario Unit price Prix unitaire	Conf. std. Std. pack Cf. std
	Arganello 11:1 Awning gearbox 11:1 Treuil 11:1	ARG11:1A	Pz		25
	Supporto braccio kenia Support for arm kenia Support bras kenia	KENI-004	Cp		10
	Supporto avvolgitore bqç kenia Support winder bqç kenia Support enrouleur bqç bqç kenia	BQCE-026	Cp		10
	Cuffie per supporto avvolgitore kenia Cover for support winder kenia Bouchons pour support enrouleur kenia	KENI-001	Cp		10
	Supporto simmetrico Support symmetrical Support symétrique	BQ40-056A	Cp		10
	Supporto universale barra quadra 40 x 40 Bracket universal square bar 40 x 40 Support universel barre carrée 40 x 40	BQC0A027	Cp		5
	Supporto braccio v 91 Support arm v 91 Support bras réglable v 91	SUPV91A	Cp		10
	Supporto braccio regolabile v 91r Support arm adjustable v 91r Support bras réglable v 91r	SUPV91REG-A	Cp		10
	Supporto universale barra quadra v10 Bracket universal square bar v10 Support universel barre carrée v10	SUPPS/V10A	Cp		20
	Scivolo raccoglibraccio in nylon Slide tray arms Goulotte ramasse-bras en nylon	SCIV00001A	Cp		100
	Tappi per terminale 30600 con viti Caps for square bar 30600 with Screws Bouchons pour barre de charge 3060 avec vis	KIR0A025	Cp		20
	Scivolo snodato in alluminio Articulated slide lux Goulotte barre de charge	LUX0004A	Cp		25
	Supporto compensatore Balance support Support compensateur	BQC0A019	Pz		10

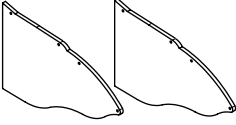
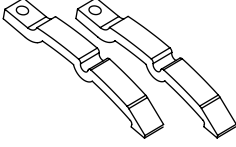
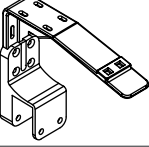
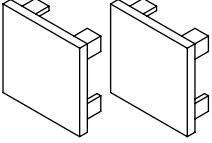
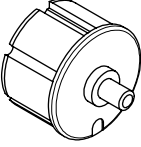
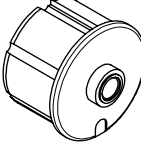
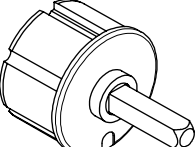
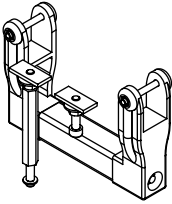
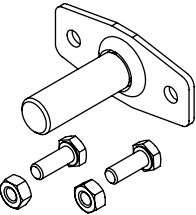
Disegno Figure Dessign	Descrizione Description Description	Codice Article Code Code Article	U.M. Unit	Prezzo unitario Unit price Prix unitaire	Conf. std. Std. pack Cf. std
	Tappi in nylon per tettino estruso Caps for roof extruded nylon Bouchons en nylon pour auvent extrudé	BQA0A029	Cp		20
	Stecchette per tettino Cues for roof Branchettes pour auvent	BQA0A029	Cp		10
	Staffe intermedie regolabili per tettino Intermediate bracket for roof Square bar Supports intermediaires réglables pour auvent	BQC0A039	Pz		10
	Tappi in nylon per barra quadra Nylon caps for square bar Bouchons en nylon pour barre carrée	BQC00024A	Cp		50
	Tappo d.70 Con perno tondo 14x20 Plug with round pin dia 70 14x20 Embout ø 70 avec axe rond 14x20	Ø 70 TAPPT70	Pz		80
	Tappo d.78 Con perno tondo 14x20 Plug with round pin dia 78 14x20 Embout ø 78 avec axe rond 14x20	Ø 78 TAPPT78			
	Tappo con foro Plug with hole Embout avec trou	Ø 70 TAPF70 Ø 78 TAPF78	Pz		200
	Tappo perno quadro ø 70 13 x 48 Plug with square ø 70 13 x 48 Embout avec axe carré ø 70 13 x 48	13x48 TAPPQ70-13x48	Pz		80
	Tappo perno quadro ø 78 13 x 48 Plug with square ø 78 13 x 48 Embout avec axe carré ø 78 13 x 48	13x48 TAPPQ80-13x48			
	Kit supporto bracci incrociati Kit support with cross arms Kit support bras croisés	BQC0A018	Pz		5
	PIASTRINA CON PERNO-PLATE WITH PIN-PLAQUETTE AVEC AXE Senza bulloni e dadi Without bolts and nuts Sans boulons et écrous Con bulloni e dadi With bolts and nuts Avec Boulons et écrous	13x40 PCP00001 13x75 PCP00002 13x40 PCP00003 13x75 PCP00004	Pz		100

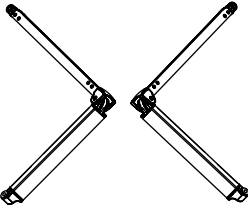
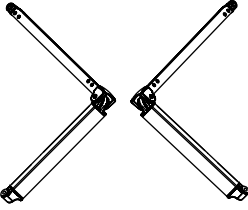
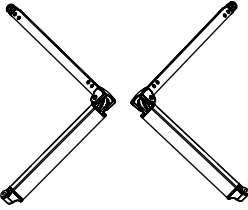
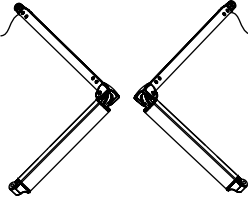
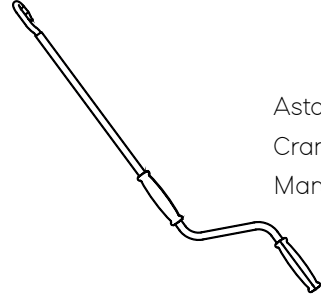
Disegno Figure Design	Descrizione Description Description	Codice Article Code Code Article	U.M. Unit	Prezzo unitario Unit price Prix unitaire	Conf. std. Std. pack Cf. std
	Bracci a catena Arms with chain Bras à chaîne	Cm 160	KIR0A160	Cp	10
		Cm 185	KIR0A185		
		Cm 210	KIR0A210		
		Cm 235	KIR0A235		
		Cm 260	KIR0A260		
		Cm 285	KIR0A285		
	Bracci a cavetto Arms with cable Bras à câble	Cm 160	CAV0A160	Cp	10
		Cm 185	CAV0A185		
		Cm 210	CAV0A210		
		Cm 235	CAV0A235		
		Cm 260	CAV0A260		
		Cm 285	CAV0A285		
	Bracci con cavetti in acciaio Rivestiti Arms with steel wires Couted Bras avec câble en acier recouvert	Cm 160	KIR0A-160F	Cp	10
		Cm 185	KIR0A-185F		
		Cm 210	KIR0A-210F		
		Cm 235	KIR0A-235F		
		Cm 260	KIR0A-260F		
		Cm 285	KIR0A-285F		
	Bracci led KIRO a catena Arms with chain Bras à chaîne	Cm 160	KIRO-LED-160A	Cp	10
		Cm 185	KIRO-LED-185A		
		Cm 210	KIRO-LED-210A		
		Cm 235	KIRO-LED-235A		
		Cm 260	KIRO-LED-260A		
		Cm 285	KIRO-LED-285A		
	Asta di manovra verniciata Crank handle Manivelle	Cm 100	AST0A100	Cp	10
		Cm 120	AST0A120		
		Cm 150	AST0A150		
		Cm 180	AST0A180		
		Cm 200	AST0A200		
		Cm 220	AST0A220		
		Cm 250	AST0A250		
Cm 300	AST0A300				

Disegno Figure Dessign	Descrizione Description Description		Codice Article Code Code Article	U.M. Unit	Prezzo unitario Unit price Prix unitaire	Conf. std. Std. pack Cf. std
------------------------------	---	--	--	--------------	--	------------------------------------

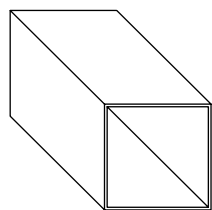

Barra quadra 40x40x2 in ferro
Zincata e verniciata
Square bar 40x40x2 iron zinc
Painted
Barre carrée 40x40x2 en
fer galvanisé et peint 2393gr/ml

Cm 400 BQC4A001
Cm 500 BQC5A001
Cm 600 BQC6A001
Cm 700 BQC7A001

Pz

10

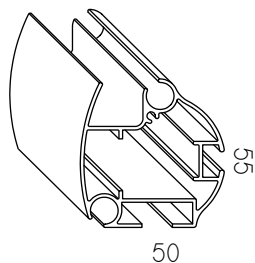

Terminale 30600
Terminal profile 30600
Barre de charge 30600
1096gr/ml

Cm 400 KIR4A001
Cm 500 KIR5A001
Cm 600 KIR6A001
Cm 700 KIR7A001

Pz

10

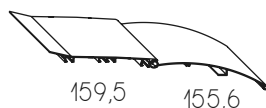

Tettino estruso
Roof extruded
Auvent extrudé
1835gr/ml

Cm 400 BQC4A1ES
Cm 500 BQC5A1ES
Cm 600 BQC6A1ES
Cm 700 BQC7A1ES

Pz

10

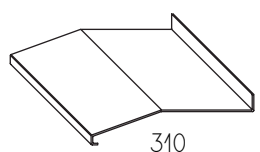

Tettino piegato
Roof allum. Bent
Auvent plié

Cm 300 BQC3A1
Cm 400 BQC4A1
Cm 500 BQC5A1
Cm 600 BQC6A1
Cm 700 BQC7A1

Pz

10

ATTENZIONE
LA KENIA CASSONATA E' REALIZZATA CON GLI STESSI ACCESSORI DELLA KENIA

ATTENTION
BOXED KENYA IS MADE WITH THE SAME ACCESSORIES AS KENIA

ATTENTION
LE KENYA EN BOÎTE EST FAIT AVEC LES MÊMES ACCESSOIRES QUE KENIA

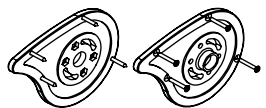

Tappi cassonetto
Cap for box
Bouchon coffre

BQCE0A004

Cp

10



Supporto cassonetto
Support for box
Support coffre

BQCE0A005

Pz

10

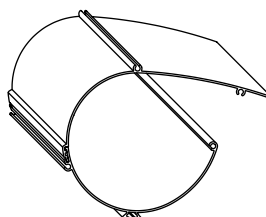

1970gr/ml

Cm 400 ELIOSCASS4A
Cm 500 ELIOSCASS5A
Cm 600 ELIOSCASS6A
Cm 700 ELIOSCASS7A

Pz

10

Note

A large rectangular area with horizontal dotted lines, intended for writing notes.

BQ 40 PLUS

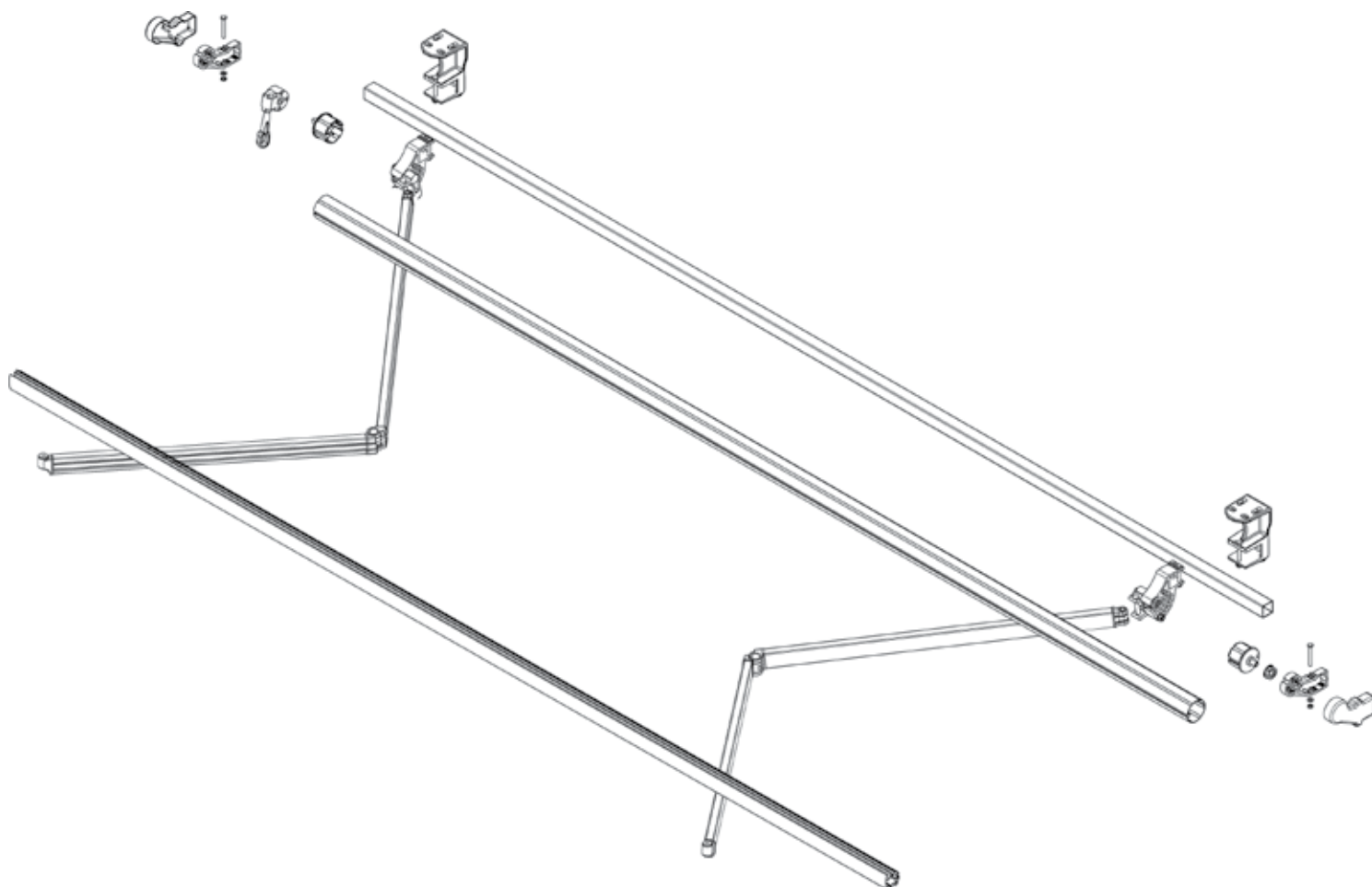

Colori di serie / Standard color / Couleurs standard



Ral
Bianco
9010

Ral
Avorio
1013

Ral
Grigio
7035

Altri colori / Another colors / Autres couleurs +20%

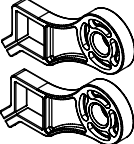
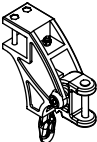
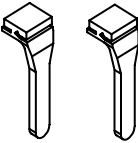
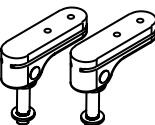
Disegno Figure Design	Descrizione Description Description	Codice Article Code Code Article	U.M. Unit	Prezzo unitario Unit price Prix unitaire	Conf. std. Std. pack Cf. std
	Arganello 11:1 Awning gearbox 11:1 Treuil 11:1	ARG11:1A	Pz		25
	Supporto braccio bq 40 plus support for arm bq 40 plus Support bras bq 40 plus	BQ40A001	Cp		25
	Supporto avvolgitore bq 40 plus Support winder bq 40 plus Support enrouleur bq 40 plus	BQ40A025	Cp		25
	Cuffie per supporto avvolgitore bq 40 plus Cover for support winder bq 40 plus Bouchons pour support enrouleur bq 40 plus	BQC0A003	Cp		10
	Supporto simmetrico Support symmetrical Support symétrique	BQ40-056A	Cp		10
	Supporto universale barra quadra 40 x 40 Bracket universal square bar 40 x 40 Support universel barre carrée 40 x 40	BQC0A027	Cp		5
	Supporto braccio v 91 Support arm v 91 Support bras réglable v 91	SUPV91A	Cp		10
	Supporto braccio regolabile v 91r Support arm adjustable v 91r Support bras réglable v 91r	SUPV91REG-A	Cp		10
	Supporto universale barra quadra v10 Bracket universal square bar v10 Support universel barre carrée v10	SUPPS/V10A	Cp		20
	Scivolo raccoglibraccio in nylon Slide tray arms Goulotte ramasse-bras en nylon	SCIV00001A	Cp		100
	Tappi per terminale 30600 con viti Caps for square bar 30600 with Screws Bouchons pour barre de charge 30600 avec vis	KIR0A025	Cp		50
	Scivolo snodato in alluminio Articulated slide lux Goulotte barre de charge	LUX0004A	Cp		25

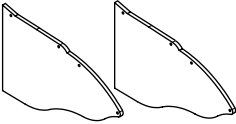
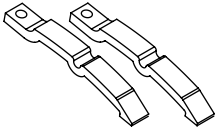
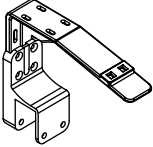
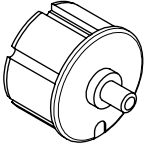
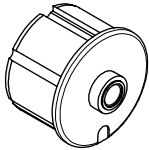
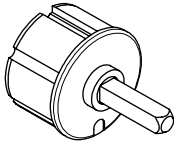
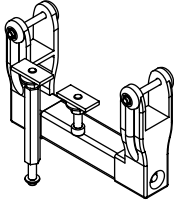
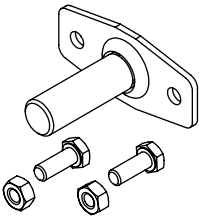
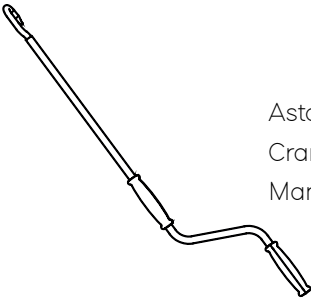
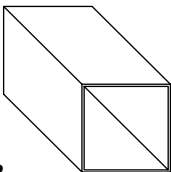
Disegno Figure Dessign	Descrizione Description Description		Codice Article Code Code Article	U.M. Unit	Prezzo unitario Unit price Prix unitaire	Conf. std. Std. pack Cf. std
	Tappi in nylon per tettino estruso Caps for roof extruded nylon Bouchons en nylon pour auvent extrudé		BQA0A029	Cp		20
	Stecchette per tettino Cues for roof Branchettes pour auvent		BQA0A029	Cp		10
	Staffe intermediale regolabili per tettino Intermediate bracket for roof Square bar Supports intermediaires réglables pour auvent		BQC0A039	Pz		10
	Tappo d.70 Con perno tondo 14x20 Plug with round pin dia 70 14x20 Embout ø 70 avec axe rond 14x20	Ø 70	TAPPT70	Pz		80
	Tappo con foro Plug with hole Embout avec trou	Ø 70	TAPF70	Pz		200
	Tappo perno quadro ø 70 Plug with square ø 70 Embout avec axe carré ø 70	13x48	TAPPQ70-13x48	Pz		80
	Kit supporto bracci incrociati Kit support with cross arms Kit support bras croisés		BQC0A018	Pz		5
	PIASTRINA CON PERNO-PLATE WITH PIN-PLAQUETTE AVEC AXE Senza bulloni e dadi Without bolts and nuts Sans boulons et écrous Con bulloni e dadi With bolts and nuts Avec Boulons et écrous	13x40 13x75 13x40 13x75	PCP00001 PCP00002 PCP00003 PCP00004	Pz		100
	Asta di manovra verniciata Crank handle Manivelle	Cm 100 Cm 120 Cm 150 Cm 180 Cm 200 Cm 220 Cm 250 Cm 300	AST0A100 AST0A120 AST0A150 AST0A180 AST0A200 AST0A220 AST0A250 AST0A300	Cp		10
	Barra quadra 40x40 in ferro Zincata e verniciata Square bar 40x40 iron zinc Painted Barre carrée 40x40 en fer galvanisé et peint	Cm 400 Cm 500 Cm 600 Cm 700	BQC4A001 BQC5A001 BQC6A001 BQC7A001	Pz		10

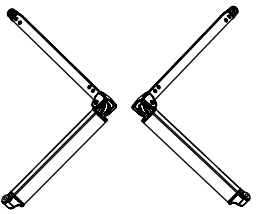
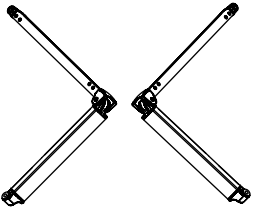
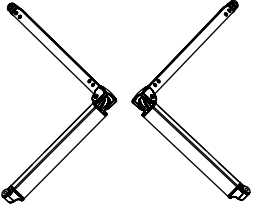
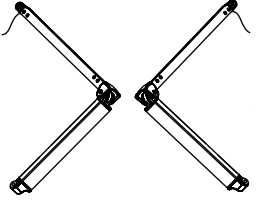
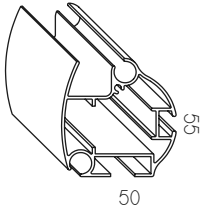
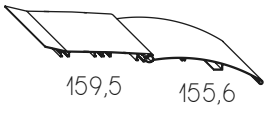
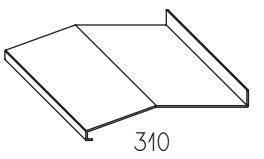
Disegno Figure Design	Descrizione Description Description	Cm	Codice Article Code Code Article	U.M. Unit	Prezzo unitario Unit price Prix unitaire	Conf. std. Std. pack Cf. std
	Bracci a catena Arms with chain Bras à chaîne	Cm 160	KIR0A160	Cp		10
		Cm 185	KIR0A185			
		Cm 210	KIR0A210			
		Cm 235	KIR0A235			
		Cm 260	KIR0A260			
		Cm 285	KIR0A285			
		Cm 310	KIR0A310			
	Bracci a cavetto Arms with cable Bras à câble	Cm 160	CAV0A160	Cp		10
		Cm 185	CAV0A185			
		Cm 210	CAV0A210			
		Cm 235	CAV0A235			
		Cm 260	CAV0A260			
		Cm 285	CAV0A285			
		Cm 310	CAV0A310			
	Bracci con cavetti in acciaio Rivestiti Arms with steel wires Couted Bras avec câble en acier recouvert	Cm 160	KIR0A-160F	Cp		10
		Cm 185	KIR0A-185F			
		Cm 210	KIR0A-210F			
		Cm 235	KIR0A-235F			
		Cm 260	KIR0A-260F			
		Cm 285	KIR0A-285F			
		Cm 310	KIR0A-310F			
	Bracci led KIRO a catena Arms with chain Bras à chaîne	Cm 160	KIRO-LED-160A	Cp		10
		Cm 185	KIRO-LED-185A			
		Cm 210	KIRO-LED-210A			
		Cm 235	KIRO-LED-235A			
		Cm 260	KIRO-LED-260A			
		Cm 285	KIRO-LED-285A			
		Cm 310	KIRO-LED-310A			
	Terminale 30600 Terminal profile 30600 Barre de charge 30600 1096gr/ml	Cm 400	KIR4A001	Pz		10
		Cm 500	KIR5A001			
		Cm 600	KIR6A001			
		Cm 700	KIR7A001			
	Tettino estruso Roof extruded Auvent extrudé 1835gr/ml	Cm 400	BQC4A1ES	Pz		10
		Cm 500	BQC5A1ES			
		Cm 600	BQC6A1ES			
		Cm 700	BQC7A1ES			
	Tettino piegato Roof allum. Bent Auvent plié	Cm 300	BQC3A1	Pz		10
		Cm 400	BQC4A1			
		Cm 500	BQC5A1			
		Cm 600	BQC6A1			
		Cm 700	BQC7A1			

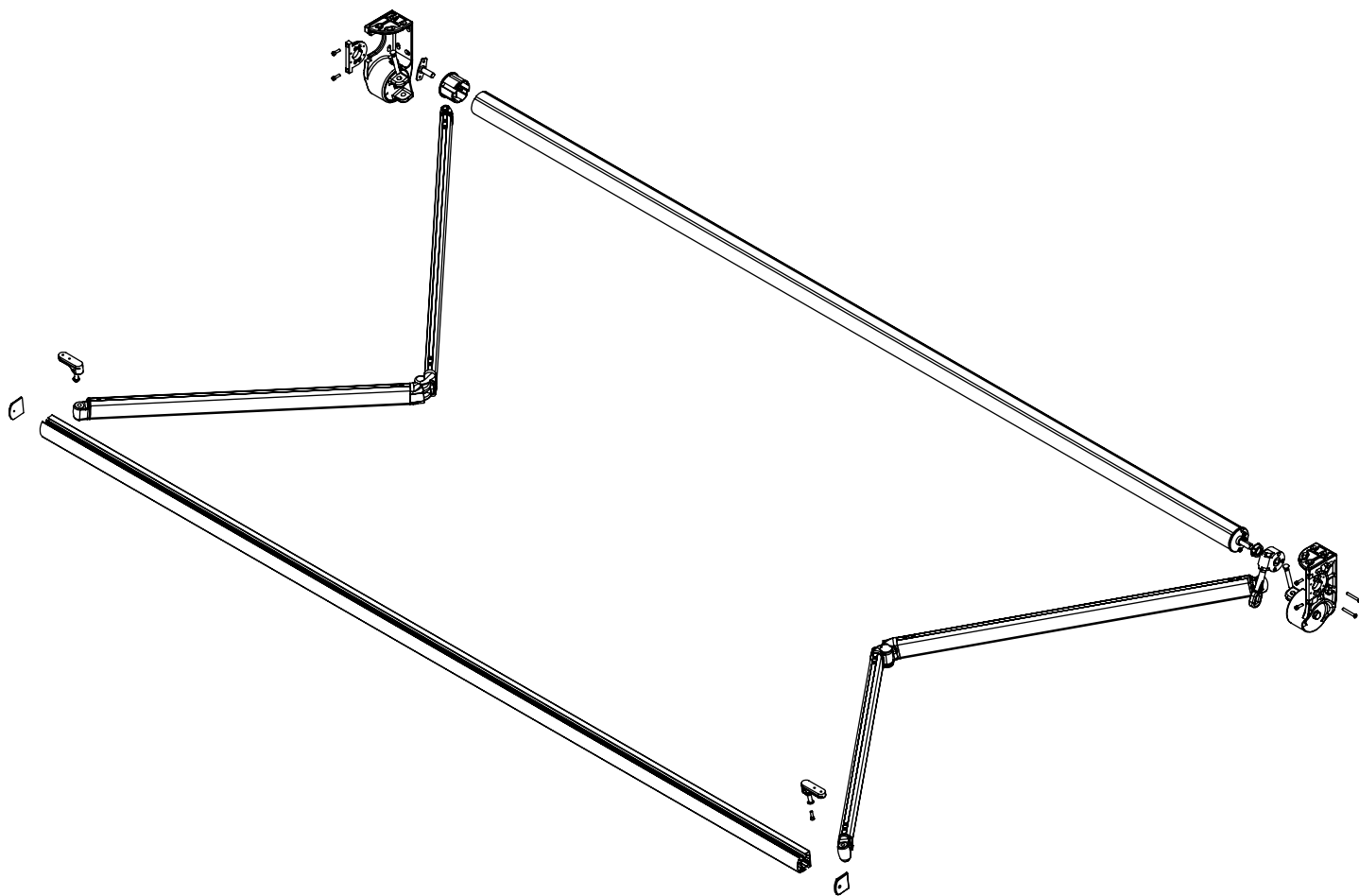

Colori di serie / Standard color / Couleurs standard



Ral
Bianco
9010

Ral
Avorio
1013

Ral
Grigio
7035

Ral
Marrone
8017

Ral
Antracite

Altri colori / Another colors / Autres couleurs +20%

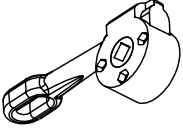
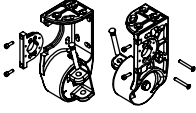
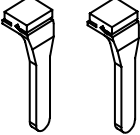
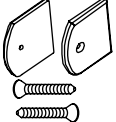
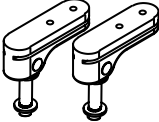
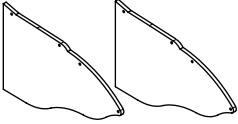
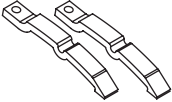
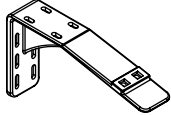
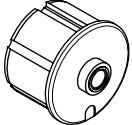
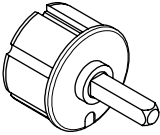
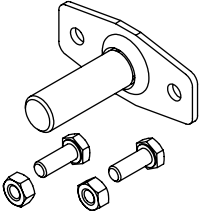
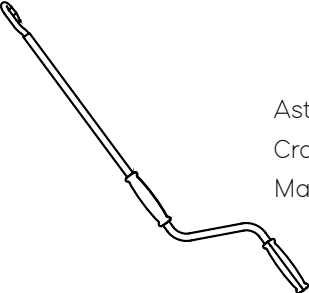
Disegno Figure Design	Descrizione Description Description	Codice Article Code Code Article	U.M. Unit	Prezzo unitario Unit price Prix unitaire	Conf. std. Std. pack Cf. std
	Arganello 11:1 Awning gearbox 11:1 Trevil 11:1	ARG11:1A	Pz		25
	Supporto parete soffitto spagna Support wall/ceiling Support mur/plafond spagna	BQCS-007A	Cp		10
	Scivolo raccoglibraccio in nylon Slide tray arms Goulotte ramasse-bras en nylon	SCIV00001A	Cp		100
	Tappi terminale 31266 con viti Caps for square bar 31226 with Screws Bouchons pour barre de charge 31226 avec vis	EURO0A025	Cp		50
	Scivolo snodato in alluminio Articulated slide lux Goulotte barre de charge	LUX0004A	Cp		25
	Tappi in nylon per tettino estruso Caps for roof extruded nylon Bouchons en nylon pour auvent extrudé	BQC0A029	Cp		20
	Stecchette per tettino Cues for roof Branchettes pour auvent	BQA0A029	Cp		10
	Staffe intermedie regolabili per tettino Intermediate bracket for roof Square bar Supports intermediaires réglables pour auvent	BQ40-017	Pz		10
	Tappo con foro Plug with hole Embout avec trou	Ø 70 TAPF70	Pz		200
	Tappo perno quadro ø 70 Plug with square ø 70 Embout avec axe carré ø 70	13x40 TAPPQ70-13X40	Cp		80
	PIASTRINA CON PERNO-PLATE WITH PIN-PLAQUETTE AVEC AXE Senza bulloni e dadi Without bolts and nuts Sans boulons et écrous Con bulloni e dadi With bolts and nuts Avec Boulons et écrous	13x40 13x75 13x40 13x75	PCP00001 PCP00002 PCP00003 PCP00004	Pz	100
	Asta di manovra verniciata Crank handle Manivelle	Cm 35 Cm 50 Cm 70 Cm 90 Cm 120 Cm 140 Cm 250 Cm 300	AST0A100 AST0A120 AST0A150 AST0A180 AST0A200 AST0A220 AST0A250 AST0A300	Pz	10

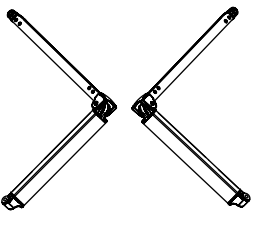
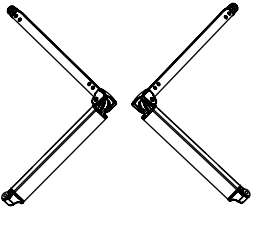
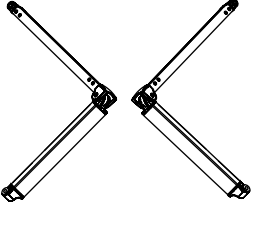
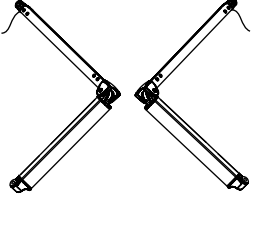
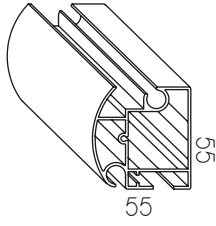
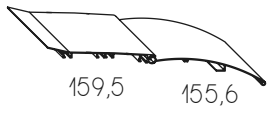
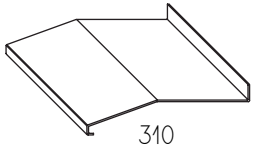
Disegno Figure Dessign	Descrizione Description Description	Codice Article Code Code Article	U.M. Unit	Prezzo unitario Unit price Prix unitaire	Conf. std. Std. pack Cf. std
	Bracci a catena Arms with chain Bras à chaîne	Cm 160	BRA0A160	Cp	10
		Cm 185	BRA0A185		
		Cm 210	BRA0A210		
		Cm 235	BRA0A235		
		Cm 260	BRA0A260		
		Cm 285	BRA0A285		
	Bracci a cavetto Arms with cable Bras à câble	Cm 160	BQCCAV0A160	Cp	10
		Cm 185	BRACAV0A185		
		Cm 210	BRACAV0A210		
		Cm 235	BRACAV0A235		
		Cm 260	BRACAV0A260		
		Cm 285	BRACAV0A285		
	Bracci con cavetti in acciaio Rivestiti Arms with steel wires Coated Bras avec câble en acier recouvert	Cm 160	BRA0A160F	Cp	10
		Cm 185	BRA0A185F		
		Cm 210	BRA0A210F		
		Cm 235	BRA0A235F		
		Cm 260	BRA0A260F		
		Cm 285	BRA0A285F		
	Bracci led a catena Arms with chain Bras à chaîne	Cm 160	BQC-LED-160A	Cp	10
		Cm 185	BQC-LED-185A		
		Cm 210	BQC-LED-210A		
		Cm 235	BQC-LED-235A		
		Cm 260	BQC-LED-260A		
		Cm 285	BQC-LED-285A		
	Terminale 31266 Terminal profile 31266 Barre de charge 31266 1276gr/ml	Cm 400	BQC4A030	Pz	10
		Cm 500	BQC5A030		
		Cm 600	BQC6A030		
		Cm 700	BQC6A030		
	Tettino estruso Roof extruded Auvent extrudé 1835gr/ml	Cm 400	BQC4A1ES	Pz	10
		Cm 500	BQC5A1ES		
		Cm 600	BQC6A1ES		
		Cm 700	BQC7A1ES		
	Tettino piegato Roof allum. Bent Auvent plié	Cm 300	BQC3A1	Pz	10
		Cm 400	BQC4A1		
		Cm 500	BQC5A1		
		Cm 600	BQC6A1		

Note

A large rectangular area with horizontal dotted lines, intended for writing notes.

OMBRA

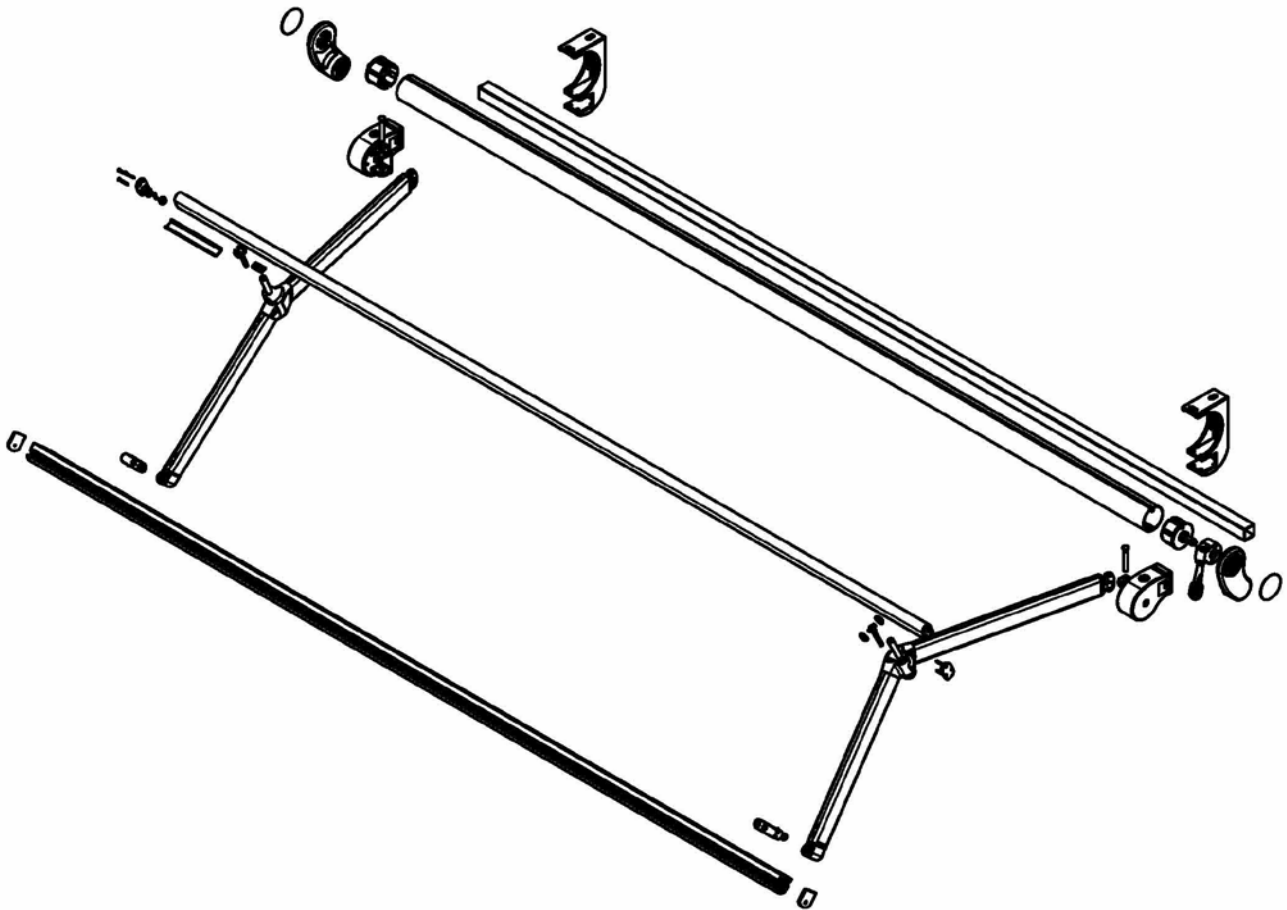

Colori di serie / Standard color / Couleurs standard



Ral	Ral	Ral	Ral
Bianco	Avorio	Grigio	Marrone
9010	1013	7035	8017

Altri colori / Another colors / Autres couleurs +20%

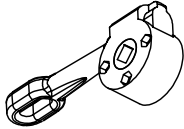
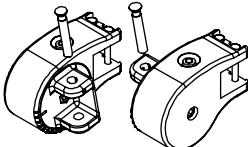
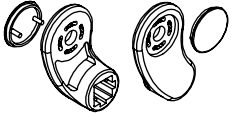
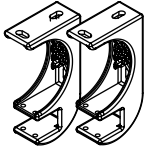
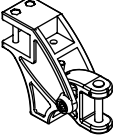
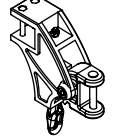
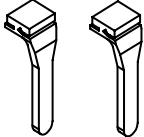
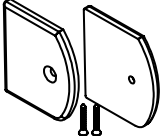
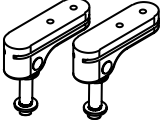
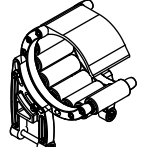
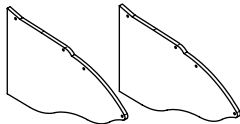
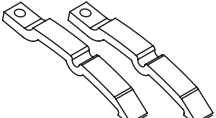
Disegno Figure Design	Descrizione Description Description	Codice Article Code Code Article	U.M. Unit	Prezzo unitario Unit price Prix unitaire	Conf. std. Std. pack Cf. std
	Arganello 11:1 Awning gearbox 11:1 TREUIL 11:1	ARG111A	Pz		25
	Supporto braccio compact C90 Support for arm compact C90 Support bras compact c90	COMP0002/90	Cp		10
	Supporto avvolgitore lux/compact Support winder bqc lux/compact Support enrouleur bqc lux/compact	LUX0002A	Cp		10
	Staffe parete soffitto bqc compact Bracket wall/ceiling compact Supports mur/plafond bqc compact	COMP0001	Cp		5
	Supporto braccio v 91 Support arm v 91 Support bras réglable v 91	SUPV91A	Cp		10
	Supporto braccio regolabile v 91r Support arm adjustable v 91r Support bras réglable v 91r	SUPV91REG-A	Cp		10
	Scivolo raccoglibraccio in nylon Slide tray arms Goulotte ramasse-bras en nylon	SCIV00001A	Cp		100
	Tappi terminale 31266 con viti Caps for terminal profile with Screws Bouchons barre de charge 31266 avec vis	EURO0A025	Cp		50
	Scivolo snodato in alluminio Articulated slide lux Goulotte barre de charge	LUX0004A	Cp		25
	Supporto compensatore Balance support for bqc compact Support compensateur	COMP0004A	Pz		10
	Tappi in nylon per tettino estruso Caps for roof extruded nylon Bouchons en nylon pour auvent extrudé	BQC0A029	Cp		20
	Stecchette per tettino Cues for roof Branchettes pour auvent	BQA0A029	Cp		10

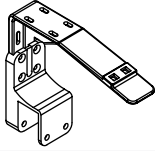
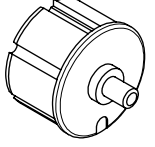
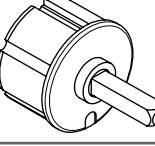
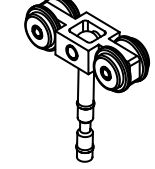
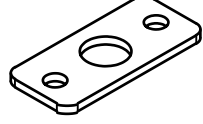
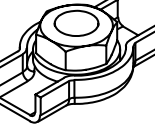
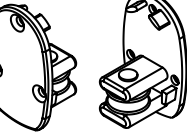
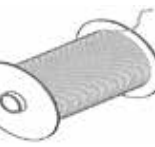
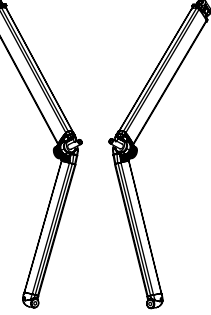
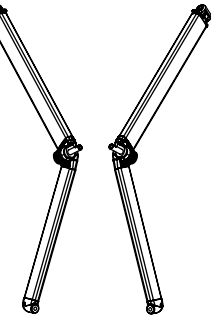
Disegno Figure Dessign	Descrizione Description Description	Codice Article Code Code Article	U.M. Unit	Prezzo unitario Unit price Prix unitaire	Conf. std. Std. pack Cf. std
	Staffe intermedie regolabili per tettino Intermediate bracket for roof Square bar Supports intermediaires réglables pour auvent	BQC0A039	Pz		10
	Tappo d.70 Con perno tondo 14x20 Plug with round pin dia 70 14x20 Embout ø 70 avec axe rond 14x20	TAPPT70	Pz		80
	Tappo perno quadro ø 70 Plug with square ø 70 Embout avec axe carré ø 70	13x48 TAPPQ70-13X48	Cp		80
	Carrello frangivento ombra Shadow windbreak ombra Chariot brise-vent ombra	OMBR-017A	Pz		10
	Piastrina per carrello frangivento Ombra Plate for trolley for windbreak Profil ombra Plaquette pour chariot brise-vent ombra	OMBR-014	Pz		10
	Morsetto simplex Morsetto simplex Étau simplex	OMBR-011	Pz		10
	Tappo frangivento ombra Caps for windbreak ombra Bouchon brise-vent ombra	OMBR-018A	Pz		10
	Corda ombra Cord ombra Corde ombra	CORD-OMBRA	MI		200
	Bracci Ombra 130° A Cavetto Arms Ombra 130° With Cable Bras Ombra 130° À Câble	Cm 135 OMBR0A135-130 Cm 160 OMBR0A160-130 Cm 185 OMBR0A185-130 Cm 210 OMBR0A210-130 Cm 235 OMBR0A235-130 Cm 260 OMBR0A260-130 Cm 285 OMBR0A285-130 Cm 310 OMBR0A310-130	Cp		10
	Bracci ombra 170° a cavetto Arms ombra 170° with cable Bras ombra 170° à câble	Cm 135 OMBR0A135-170 Cm 160 OMBR0A160-170 Cm 185 OMBR0A185-170 Cm 210 OMBR0A210-170 Cm 235 OMBR0A235-170 Cm 260 OMBR0A260-170 Cm 285 OMBR0A285-170 Cm 310 OMBR0A310-170	Cp		10

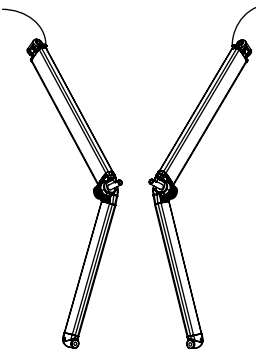
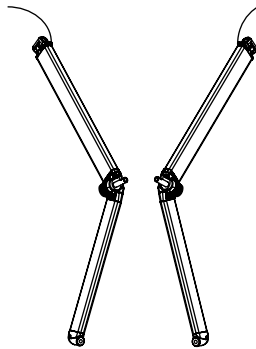
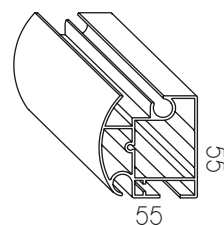
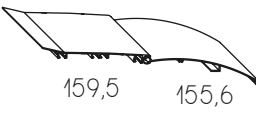
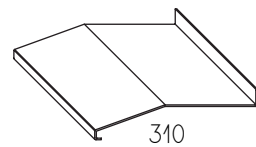
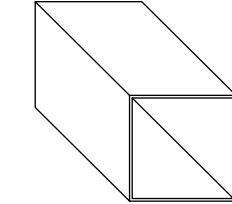
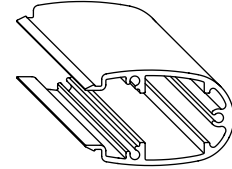
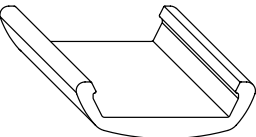
Disegno Figure Design	Descrizione Description Description	Codice Article Code Code Article	U.M. Unit	Prezzo unitario Unit price Prix unitaire	Conf. std. Std. pack Cf. std
	Bracci Ombra 130° A Cavetto Arms Ombra 130° With Cable Bras Ombra 130° À Câble	Cm 135	OMBR0A135-130L	Cp	10
		Cm 160	OMBR0A160-130L		
		Cm 185	OMBR0A185-130L		
		Cm 210	OMBR0A210-130L		
		Cm 235	OMBR0A235-130L		
		Cm 260	OMBR0A260-130L		
		Cm 285	OMBR0A285-130L		
Cm 310	OMBR0A310-130L				
	Bracci ombra 170° a cavetto Arms ombra 170° with cable Bras ombra 170° à câble	Cm 135	OMBR0A135-170L	Cp	10
		Cm 160	OMBR0A160-170L		
		Cm 185	OMBR0A185-170L		
		Cm 210	OMBR0A210-170L		
		Cm 235	OMBR0A235-170L		
		Cm 260	OMBR0A260-170L		
		Cm 285	OMBR0A285-170L		
Cm 310	OMBR0A310-170L				
	Terminale 31266 Terminal profile 31266 Barre de charge 31266 1276gr/ml	Cm 400	BQC4A030	Pz	10
		Cm 500	BQC5A030		
		Cm 600	BQC6A030		
		Cm 700	BQC6A030		
	Tettino estruso Roof extruded Auvent extrudé 1835gr/ml	Cm 400	BQC4A1ES	Pz	10
		Cm 500	BQC5A1ES		
		Cm 600	BQC6A1ES		
		Cm 700	BQC7A1ES		
	Tettino piegato Roof allum. Bent Auvent plié	Cm 300	BQC3A1	Pz	10
		Cm 400	BQC4A1		
		Cm 500	BQC5A1		
		Cm 600	BQC6A1		
	Barra quadra 40x40 in ferro Zincata e verniciata Square bar 40x40 iron zinc Painted Barre carrée 40x40 en fer galvanisé et peint 2393gr/ml	Cm 400	BQC4A001	Pz	10
		Cm 500	BQC5A001		
		Cm 600	BQC6A001		
		Cm 700	BQC7A001		
	Frangivento ombra Windbreak ombra Brise-vent ombra 946gr/ml	Cm 400	FGOMBRA4	Pz	10
		Cm 500	FGOMBRA5		
		Cm 600	FGOMBRA6		
		Cm 700	FGOMBRA7		
	Coprifilo frangivento ombra Cover rope for windbreak Ombra Couvre-fil brise-vent ombra 282gr/ml	Cm 500	CFOMBRA5	Pz	10

KIRO 40 BQ

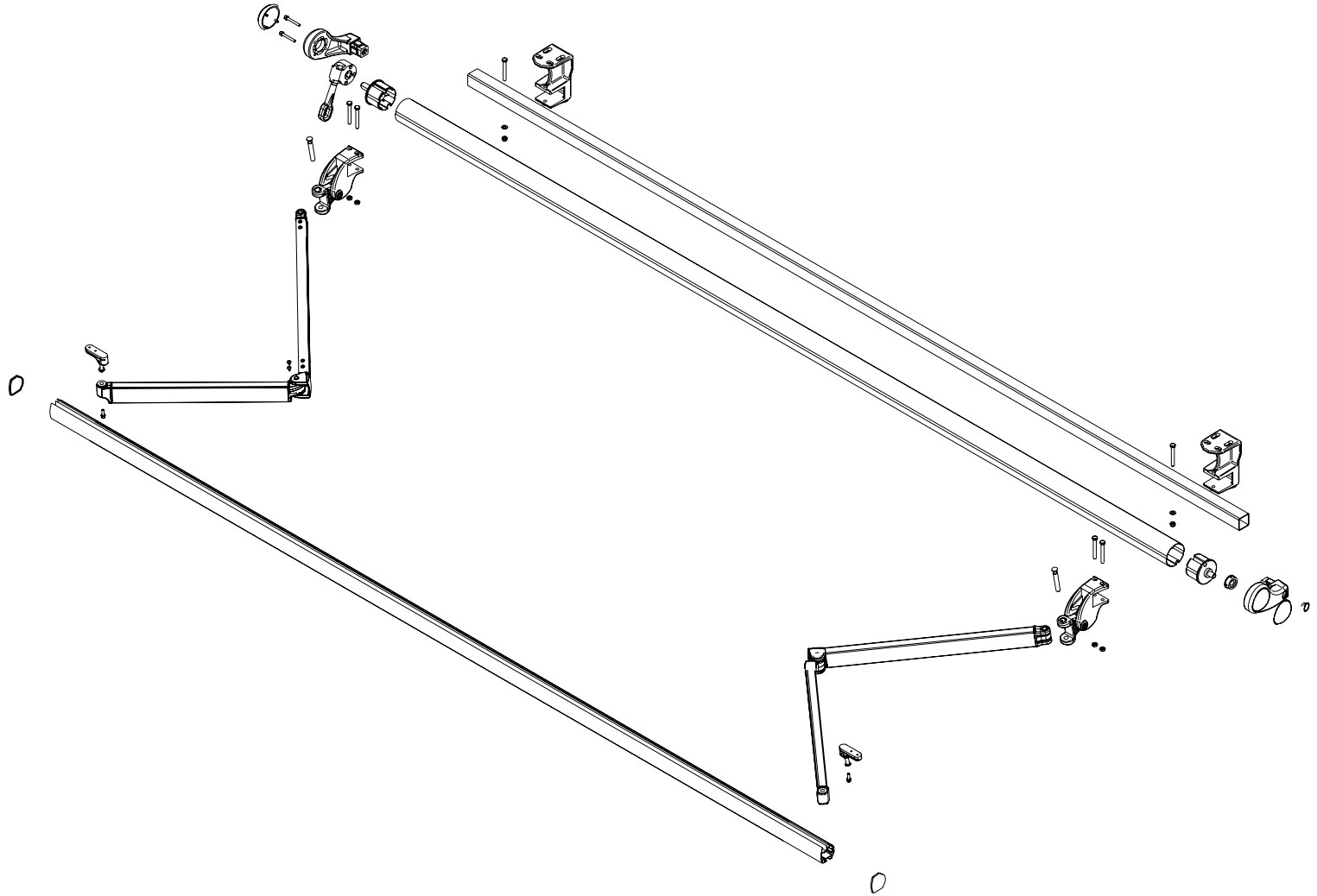
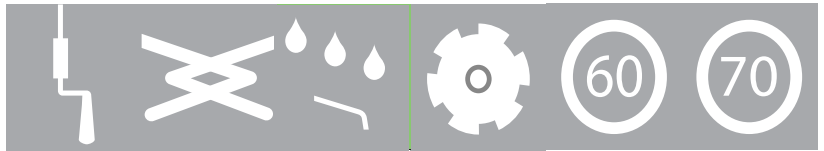

Colori di serie / Standard color / Couleurs standard



Ral Bianco 9010	Ral Verde 6005	Ral Avorio 1013	Ral Marrone 8017	Ral Grigio 7035
	Ral Antracite	Ral Bronzo	Ral Nero opaco 9005	

Altri colori / Another colors / Autres couleurs +20%

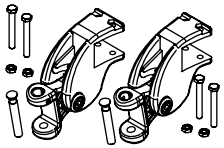
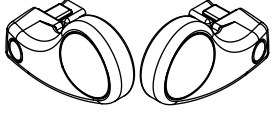
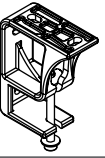
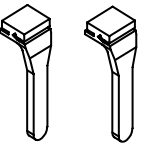
Disegno Figure Design	Descrizione Description Description	Codice Article Code Code Article	U.M. Unit	Prezzo unitario Unit price Prix unitaire	Conf. std. Std. pack Cf. std
	Arganello 11:1 Awning gearbox 11:1 Treuil 11:1	ARG11A	Pz		25
	Supporto braccio kiro 40 Support for arm kiro 40 Support bras kiro 40	KIR0A024	Cp		10
	Supporto avvolgitore kiro 40 Support winder kiro 40 Support enrouleur kiro 40	KIR0A023	Cp		10
	Supporto universale barra quadra 40 x 40 Bracket universal square bar 40 x 40 Support universel barre carrée 40 x 40	BQC0A027	Cp		5
	Supporto simmetrico Support symmetrical Support symétrique	BQ40-056A	Cp		10
	Staffa sottotetto Roof bracket on square bar Support sous-toit	BQ40-015A	Cp		10
	Supporto braccio v 91 Support arm v 91 Support bras réglable v 91	SUPV91A	Cp		100
	Supporto braccio regolabile v 91r Support arm adjustable v 91r Support bras réglable v 91r	SUPV91REG-A	Cp		50
	Supporto universale barra quadra v10 Bracket universal square bar v10 Support universel barre carrée v10	SUPPS/V10A	Cp		25
	Scivolo raccoglibraccio in nylon Slide tray arms Goulotte ramasse-bras en nylon	SCIV00001A	Cp		10
	Tappi per terminale 30600 con viti Caps for square bar 30600 with Screws Bouchons pour barre de charge 3060 avec vis	KIR0A025	Cp		20
	Scivolo snodato in alluminio Articulated slide lux Goulotte barre de charge	LUX0004A	Cp		10

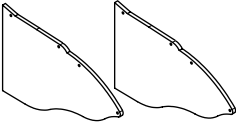
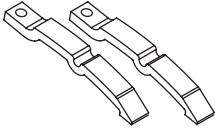
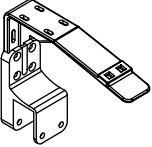
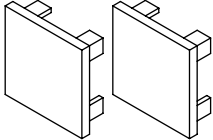
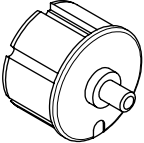
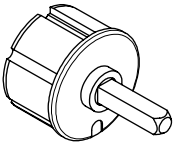
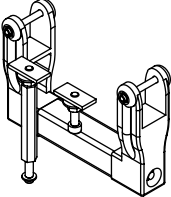
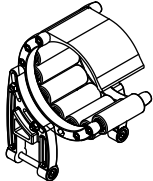
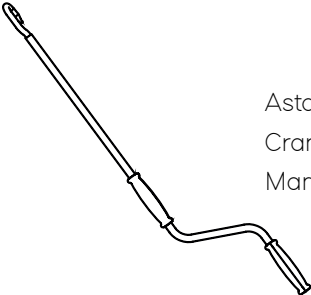
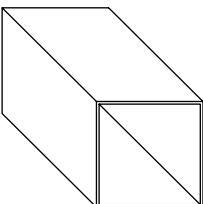
Disegno Figure Dessign	Descrizione Description Description	Codice Article Code Code Article	U.M. Unit	Prezzo unitario Unit price Prix unitaire	Conf. std. Std. pack Cf. std
	Tappi in nylon per tettino estruso Caps for roof extruded nylon Bouchons en nylon pour auvent extrudé	BQC0A029	Cp		20
	Stecchette per tettino Cues for roof Branchettes pour auvent	BQA0A029	Cp		10
	Staffe intermedie regolabili per tettino Intermediate bracket for roof Square bar Supports intermediaires réglables pour auvent	BQC0A039	Cp		10
	Tappi in nylon per barra quadra Nylon caps for square bar Bouchons en nylon pour barre carrée	BQC00024A	Cp		50
	Tappo d.70 Con perno tondo 14x20 Plug with round pin dia 70 14x20 Embout ø 70 avec axe rond 14x20	TAPPT70	Pz		80
	Tappo perno quadro ø 70 Plug with square ø 70 Embout avec axe carré ø 70	13x48 TAPPQ80-13x48	Cp		80
	Kit supporto bracci incrociati Kit support with cross arms Kit support bras croisés	BQC0A018	Pz		5
	Supporto compensatore Balance support Support compensateur	BQC0A019	Cp		10
	Asta di manovra verniciata Crank handle Manivelle	Cm 35	AST0A100	Pz	10
		Cm 50	AST0A120		
		Cm 70	AST0A150		
		Cm 90	AST0A180		
		Cm 120	AST0A200		
		Cm 140	AST0A220		
		Cm 250	AST0A250		
Cm 300	AST0A300				
	Barra quadra 40x40 in ferro Zincata e verniciata Square bar 40x40 iron zinc Painted Barre carrée 40x40 en fer galvanisé et peint	Cm 400	BQC4A001	Pz	10
		Cm 500	BQC5A001		
		Cm 600	BQC6A001		
		Cm 700	BQC7A001		
			2393gr/ml		

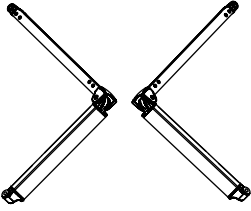
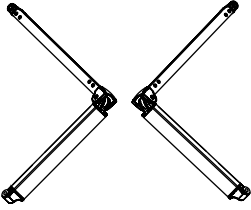
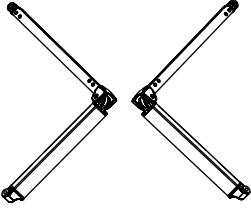
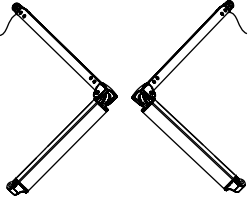
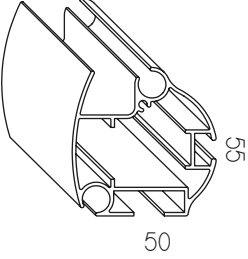
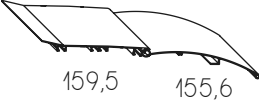
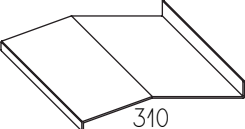
Disegno Figure Design	Descrizione Description Description	Codice Article Code Code Article	U.M. Unit	Prezzo unitario Unit price Prix unitaire	Conf. std. Std. pack Cf. std
	Bracci a catena Arms with chain Bras à chaîne	Cm 160	KIR0A160	Cp	10
		Cm 185	KIR0A185		
		Cm 210	KIR0A210		
		Cm 235	KIR0A235		
		Cm 260	KIR0A260		
		Cm 285	KIR0A285		
		Cm 310	KIR0A310		
	Bracci a cavetto Arms with cable Bras à câble	Cm 160	CAV0A160	Cp	10
		Cm 185	CAV0A185		
		Cm 210	CAV0A210		
		Cm 235	CAV0A235		
		Cm 260	CAV0A260		
		Cm 285	CAV0A285		
		Cm 310	CAV0A310		
	Bracci con cavetti in acciaio Rivestiti Arms with steel wires Couted Bras avec câble en acier recouvert	Cm 160	KIR0A-160F	Cp	10
		Cm 185	KIR0A-185F		
		Cm 210	KIR0A-210F		
		Cm 235	KIR0A-235F		
		Cm 260	KIR0A-260F		
		Cm 285	KIR0A-285F		
		Cm 310	KIR0A-310F		
	Bracci led KIRO a catena Arms with chain Bras à chaîne	Cm 160	KIRO-LED-160A	Cp	10
		Cm 185	KIRO-LED-185A		
		Cm 210	KIRO-LED-210A		
		Cm 235	KIRO-LED-235A		
		Cm 260	KIRO-LED-260A		
		Cm 285	KIRO-LED-285A		
		Cm 310	KIRO-LED-310A		
	Terminale 30600 Terminal profile 30600 Barre de charge 30600 1096gr/ml	Cm 400	KIR4A001	Pz	10
		Cm 500	KIR5A001		
		Cm 600	KIR6A001		
		Cm 700	KIR7A001		
	Tettino estruso Roof extruded Auvent extrudé 1835gr/ml	Cm 400	BQC4A1ES	Pz	10
		Cm 500	BQC5A1ES		
		Cm 600	BQC6A1ES		
		Cm 700	BQC7A1ES		
	Tettino piegato Roof allum. Bent Auvent plié	Cm 300	BQC3A1	Pz	10
		Cm 400	BQC4A1		
		Cm 500	BQC5A1		
		Cm 600	BQC6A1		
		Cm 700	BQC7A1		

LIBERTY P/S ECLISSE



LIBERTY

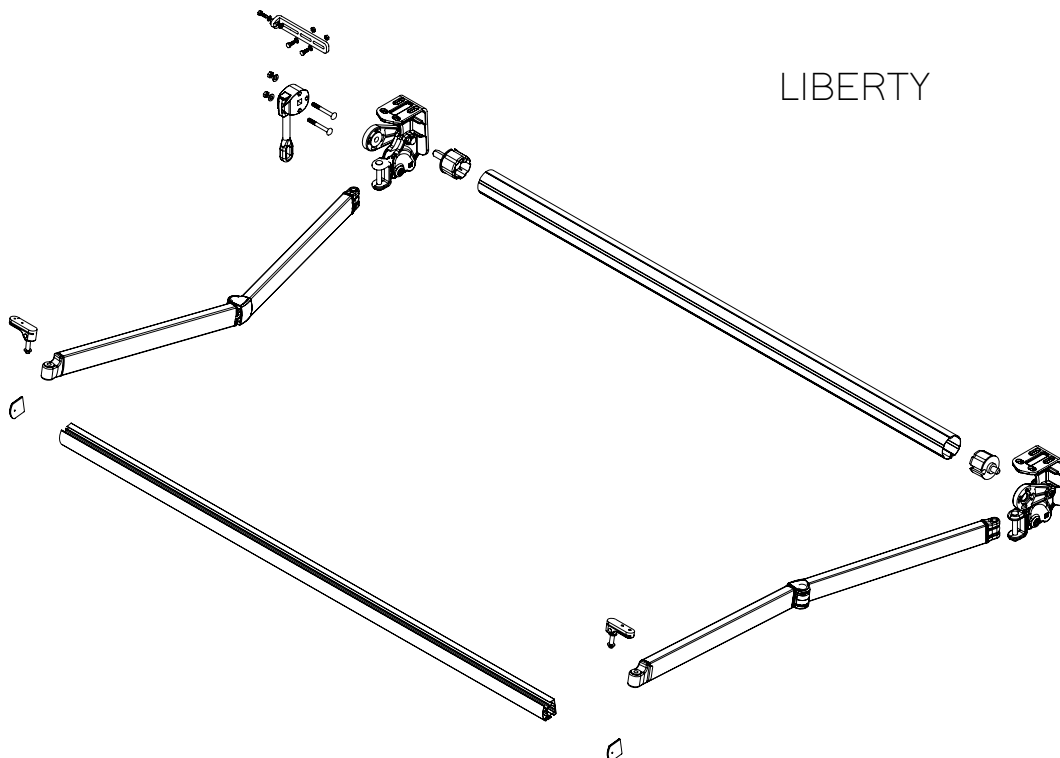

ECLISSE

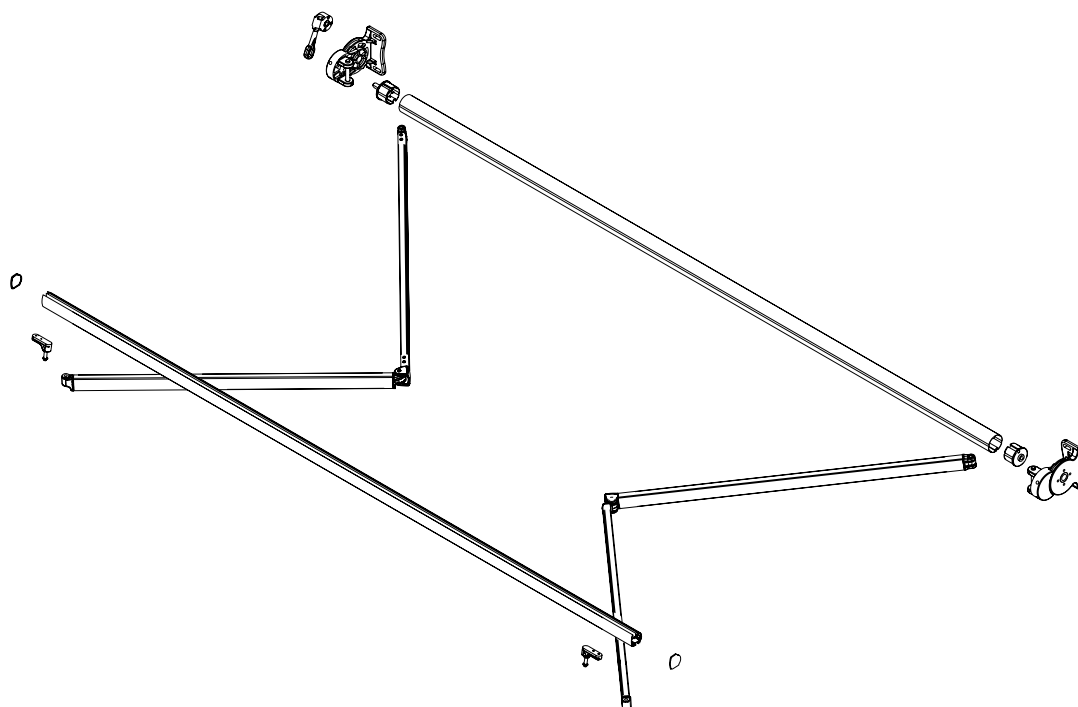

Colori di serie / Standard color / Couleurs standard



Ral Bianco 9010	Ral Verde 6005	Ral Avorio 1013	Ral Marrone 8017	Ral Grigio 7035
	Ral Antracite	Ral Bronzo	Ral Nero opaco 9005	

Altri colori / Another colors / Autres couleurs +20%

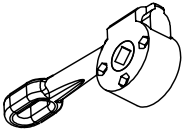
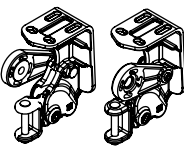
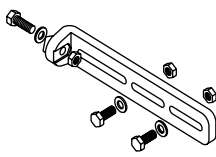
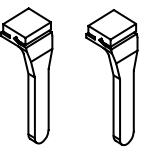
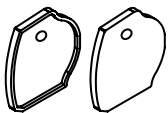
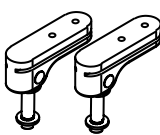
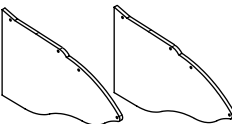
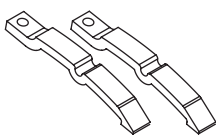
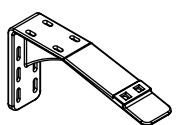
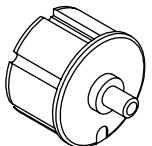
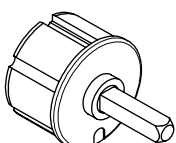
Disegno Figure Design	Descrizione Description Description	Codice Article Code Code Article	U.M. Unit	Prezzo unitario Unit price Prix unitaire	Conf. std. Std. pack Cf. std
	Arganello 11:1 Awning gearbox 11:1 Treuril 11:1	ARG11:A	Pz		25
	Supporto parete soffitto leva incastro Support wall/ceiling liberty lever Snap Support mur/plafond à encastrement	TL0A001	Cp		10
	Supporto motore con soccorso Engine support with rescue Support moteur avec sauvetage	TL0A003	Pz		10
	Scivolo raccoglibraccio in nylon Slide tray arms Goulotte ramasse-bras en nylon	SCIV00001A	Cp		100
	Tappi per terminale 30600 con viti Caps for square bar 30600 with Screws Bouchons pour barre de charge 3060 avec vis	KIR0A025	Cp		50
	Scivolo snodato in alluminio Articulated slide lux Goulotte barre de charge	LUX0004A	Cp		25
	Tappi in nylon per tettino estruso Caps for roof extruded nylon Bouchons en nylon pour auvent extrudé	BQA0A029	Cp		20
	Stecchette per tettino Cues for roof Branchettes pour auvent	BQA0A029	Cp		10
	Staffe intermedie regolabili per tettino Intermediate bracket for roof Square bar Supports intermediaires réglables pour auvent	BQ40-017	Pz		10
	Tappo d.70 Con perno tondo 14x20 Plug with round pin dia 70 14x20 Embout ø 70 avec axe rond 14x20	TAPPT70	Pz		80
	Tappo perno quadro ø 70 Plug with square ø 70 Embout avec axe carré ø 70	13x55 TAPPQ70-13X55	Pz		80

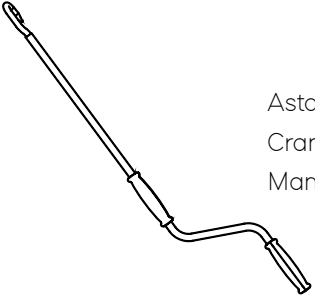
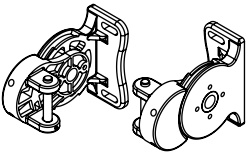
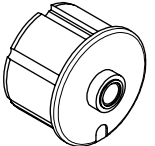
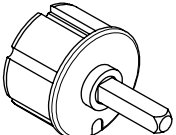
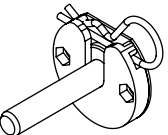
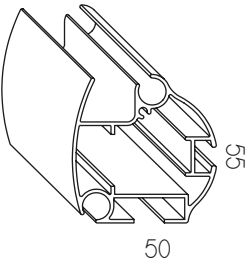
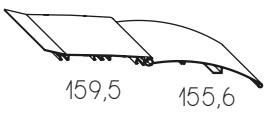
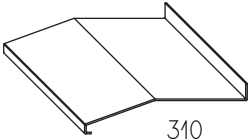
Disegno Figure Dessign	Descrizione Description Description		Codice Article Code Code Article	U.M. Unit	Prezzo unitario Unit price Prix unitaire	Conf. std. Std. pack Cf. std
	Asta di manovra verniciata Crank handle Manivelle	Cm 35	AST0A100	Pz		10
		Cm 50	AST0A120			
		Cm 70	AST0A150			
		Cm 90	AST0A180			
		Cm 120	AST0A200			
		Cm 140	AST0A200			
		Cm 250	AST0A250			
		Cm 300	AST0A300			
	Supporto parete soffitto eclisse * Support wall/ceiling eclisse * Support mur/plafond eclisse * *Solo nei colori di serie/standard colors Ral 9010, ral 1013, ral 7035, ral 8017, antracite.		ECLI006A	Cp		10
	Tappo con foro Plug with hole Embout avec trou	∅ 70	TAPF70	Pz		200
	Tappo perno quadro ∅ 70 Plug with square ∅ 70 Embout avec axe carré ∅ 70	13x70	TAPPQ70-13X70	Pz		80
	Piastrina in nylon con perno estraibile Plate nylon with removable pin Plaquette en nylon avec axe extraible		PES0005	Pz		100
	Terminale 30600 Terminal profile 30600 Barre de charge 30600 1096gr/ml	Cm 400 Cm 500 Cm 600 Cm 700	KIR4A001 KIR5A001 KIR6A001 KIR7A001	Pz		10
	Tettino estruso Roof extruded Auvent extrudé 1835gr/ml	Cm 400 Cm 500 Cm 600 Cm 700	BQC4A1ES BQC5A1ES BQC6A1ES BQC7A1ES	Pz		10
	Tettino piegato Roof allum. Bent Auvent plié	Cm 300 Cm 400 Cm 500 Cm 600	BQC3A1 BQC4A1 BQC5A1 BQC6A1	Pz		10

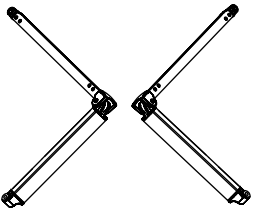
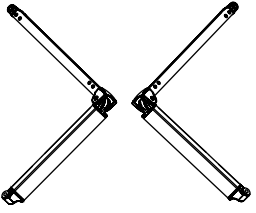
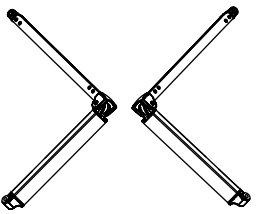
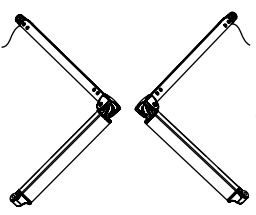
Disegno Figure Design	Descrizione Description Description	Codice Article Code Code Article	U.M. Unit	Prezzo unitario Unit price Prix unitaire	Conf. std. Std. pack Cf. std
	Bracci a catena Arms with chain Bras à chaîne	Cm 160	KIR0A160	Cp	10
		Cm 185	KIR0A185		
		Cm 210	KIR0A210		
		Cm 235	KIR0A235		
		Cm 260	KIR0A260		
		Cm 285	KIR0A285		
		Cm 310	KIR0A310		
	Bracci a cavetto Arms with cable Bras à câble	Cm 160	CAV0A160	Cp	10
		Cm 185	CAV0A185		
		Cm 210	CAV0A210		
		Cm 235	CAV0A235		
		Cm 260	CAV0A260		
		Cm 285	CAV0A285		
		Cm 310	CAV0A310		
	Bracci con cavetti in acciaio Rivestiti Arms with steel wires Couted Bras avec câble en acier recouvert	Cm 160	KIR0A-160F	Cp	10
		Cm 185	KIR0A-185F		
		Cm 210	KIR0A-210F		
		Cm 235	KIR0A-235F		
		Cm 260	KIR0A-260F		
		Cm 285	KIR0A-285F		
		Cm 310	KIR0A-310F		
	Bracci led KIRO a catena Arms with chain Bras à chaîne	Cm 160	KIRO-LED-160A	Cp	10
		Cm 185	KIRO-LED-185A		
		Cm 210	KIRO-LED-210A		
		Cm 235	KIRO-LED-235A		
		Cm 260	KIRO-LED-260A		
		Cm 285	KIRO-LED-285A		
		Cm 310	KIRO-LED-310A		

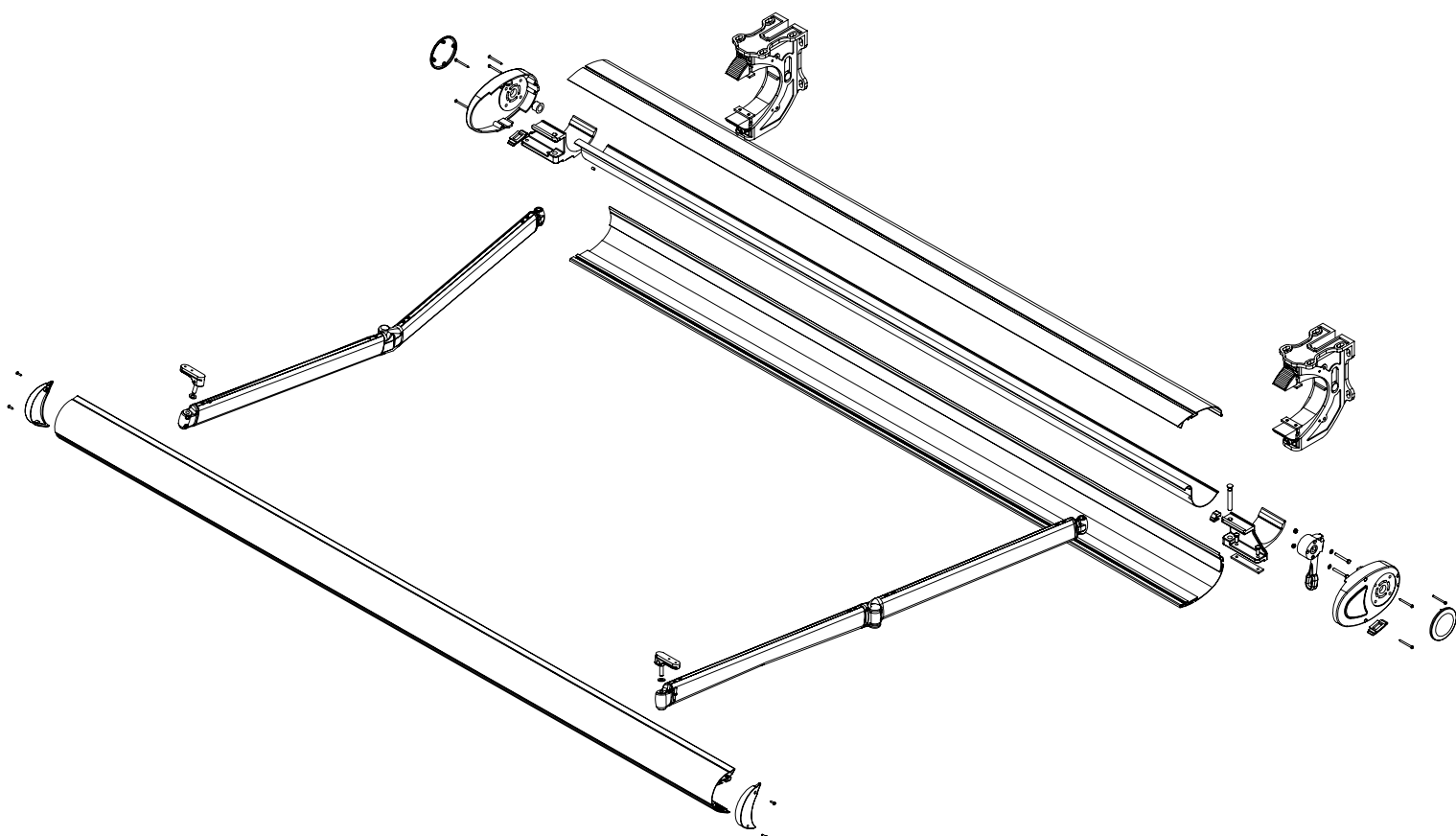

Colori di serie / Standard color / Couleurs standard



Ral
Bianco
9010

Ral
Avorio
1013

Ral
Grigio
7035

Ral
Antracite

Altri colori / Another colors / Autres couleurs +20%

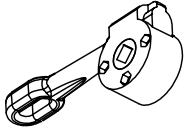
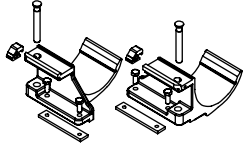
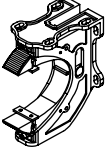
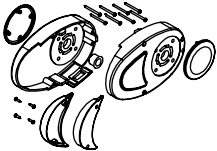
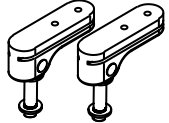
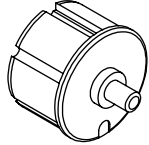
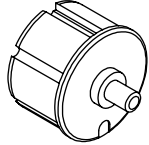
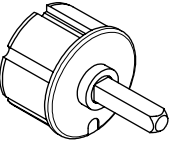
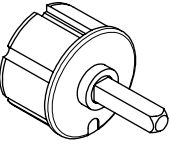
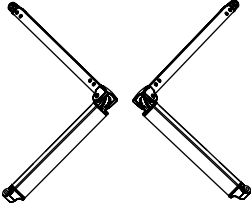
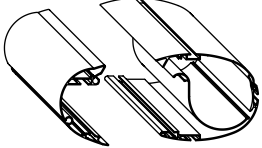
Disegno Figure Design	Descrizione Description Description	Codice Article Code Code Article	U.M. Unit	Prezzo unitario Unit price Prix unitaire	Conf. std. Std. pack Cf. std
	Arganello 11:1 Awning gearbox 11:1 Treuril 11:1	ARG11A	Pz		25
	Supporto braccio europa con scivolo Support arm europa with slide Support bras europa avec goulotte	ARM0A0001	Cp		10
	Supporto cassonetto europa Support box europa Support coffre	ARM0A0003PS	Pz		5
	Kit tappi cassonetto e terminale Kit caps with caps for terminal Profile Kit bouchons coffre et barre de charge	ARM0A0004	Cp		5
	Scivolo snodato in alluminio Articulated slide lux Goulotte barre de charge	LUX0004A	Cp		25
	Tappo d.70 Con perno tondo 14x20 Plug with round pin dia 70 14x20 Embout ø 70 avec axe rond 14x20	TAPPT70	Pz		80
	Tappo d.78 Con perno tondo 14x20 Plug with round pin dia 78 14x20 Embout ø 78 avec axe rond 14x20	TAPPT78	Pz		80
	Tappo perno quadro ø 70 Plug with square ø 70 Embout avec axe carré ø 70	13x40 TAPPQ70-13x40	Pz		80
	Tappo perno quadro ø 78 Plug with square ø 78 Embout avec axe carré ø 78	13x48 TAPPQ80-13x48	Pz		80
	Bracci a catena twister Arms with chain twister Bras à chaîne twister	Cm 160 TWS0A160 Cm 185 TWS0A185 Cm 210 TWS0A210 Cm 235 TWS0A235 Cm 260 TWS0A260 Cm 285 TWS0A285 Cm 310 TWS0A310 Cm 360 TWS0A360	Cp		10
	Kit profili europa 4000 (Cassonetto e terminale) kit profiles europa 4000 (Box and terminal profile) Kit profils europa 4000 (Coffre et barre de charge)	Cm 400 ARM4A005 Cm 500 ARM5A005 Cm 600 ARM6A005 Cm 700 ARM7A005	Pz		5

7468gr/ml

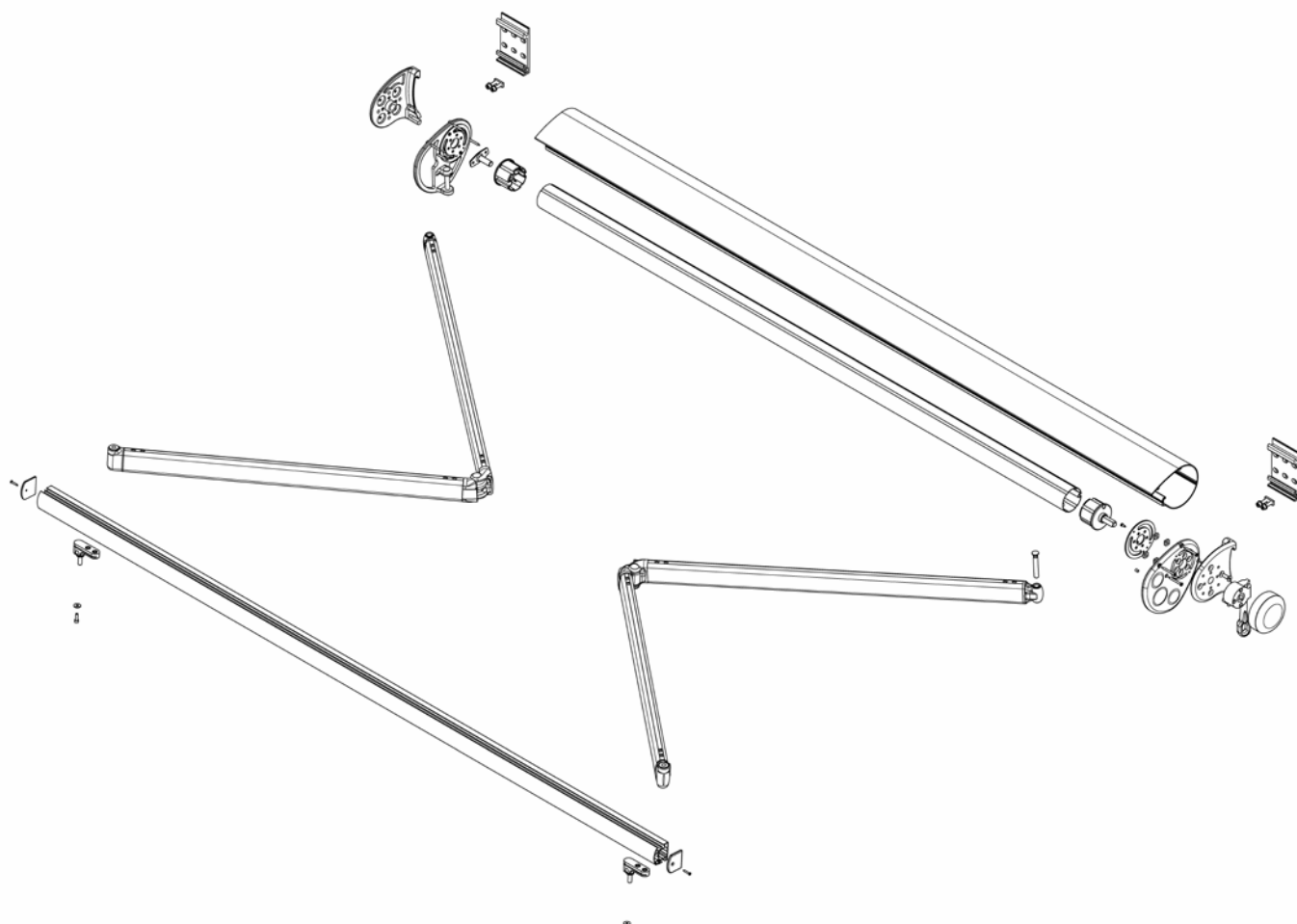



Colori di serie / Standard color / Couleurs standard

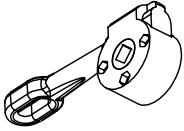
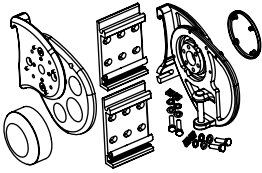
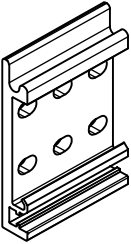
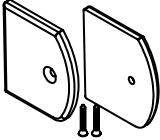
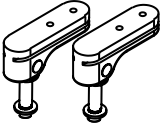
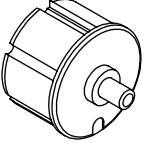
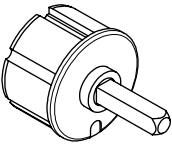

Ral	Ral
Bianco	Avorio
9010	1013

Altri colori / Another colors / Autres couleurs +20%

Disegno Figure Design	Descrizione Description Description	Codice Article Code Code Article	U.M. Unit	Prezzo unitario Unit price Prix unitaire	Conf. std. Std. pack Cf. std
	Arganello 11:1 Awning gearbox 11:1 Treuil 11:1	ARG11:1A	Pz		25
	Kit supporti varese con cuffie e Staffe Kit support varese with caps and Brackets Kit supports varese avec bouchons	KITVAR	Pz		5
	Supporto parete soffitto Support wall/ceiling Support mur/plafond	F430A-001	Pz		5
	Tappi terminale 31266 con viti Caps for terminal profile with Screws Bouchons barre de charge 31266 avec vis	EURO0A025	Cp		50
	Scivolo snodato in alluminio Articulated slide lux Goulotte barre de charge	LUX0004A	Cp		10
	Tappo d.70 Con perno tondo 14x20 Plug with round pin dia 70 14x20 Embout ø 70 avec axe rond 14x20	TAPPT70	Pz		80
	Tappo perno quadro ø 70 Plug with square ø 70 Embout avec axe carré ø 70	13x70 TAPPQ70-13x70	Pz		80
	Asta di manovra verniciata Crank handle Manivelle	Cm 35 Cm 50 Cm 70 Cm 90 Cm 120 Cm 140 Cm 250 Cm 300	AST0A100 AST0A120 AST0A150 AST0A180 AST0A200 AST0A220 AST0A250 AST0A300	Pz	10

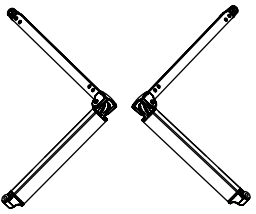
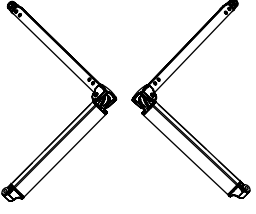
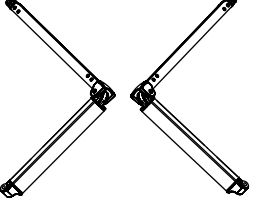
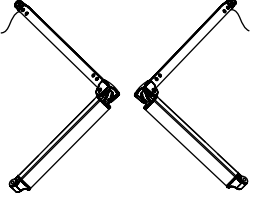
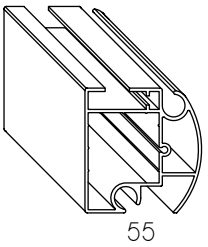
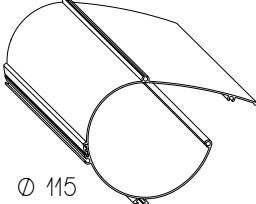
Disegno Figure Dessign	Descrizione Description Description	Codice Article Code Code Article	U.M. Unit	Prezzo unitario Unit price Prix unitaire	Conf. std. Std. pack Cf. std
	Bracci a catena Arms with chain Bras à chaîne	Cm 160	BRA0A160	Cp	10
		Cm 185	BRA0A185		
		Cm 210	BRA0A210		
		Cm 235	BRA0A235		
		Cm 260	BRA0A260		
	Bracci a cavetto Arms with cable Bras à câble	Cm 160	BQCCAV0A160	Cp	10
		Cm 185	BRACAV0A185		
		Cm 210	BRACAV0A210		
		Cm 235	BRACAV0A235		
		Cm 260	BRACAV0A260		
	Bracci con cavetti in acciaio Rivestiti Arms with steel wires Couted Bras avec câble en acier recouvert	Cm 160	BRA0A160F	Cp	10
		Cm 185	BRA0A185F		
		Cm 210	BRA0A210F		
		Cm 235	BRA0A235F		
		Cm 260	BRA0A260F		
	Bracci led a catena Arms with chain Bras à chaîne	Cm 160	BQC-LED-160A	Cp	10
		Cm 185	BQC-LED-185A		
		Cm 210	BQC-LED-210A		
		Cm 235	BQC-LED-235A		
		Cm 260	BQC-LED-260A		
	Terminale 31266 Terminal profile 31266 Barre de charge 31266 1276gr/ml	Cm 400	BQC4A030	Pz	10
		Cm 500	BQC5A030		
		Cm 600	BQC6A030		
		Cm 700	BQC6A030		
	Cassonetto elios Box elios Coffre elios 1970gr/ml	Cm 400	ELIOSCASS4A	Pz	10
		Cm 500	ELIOSCASS5A		
		Cm 600	ELIOSCASS6A		

Note

A large rectangular area with horizontal dotted lines, intended for writing notes.

STAR BOX

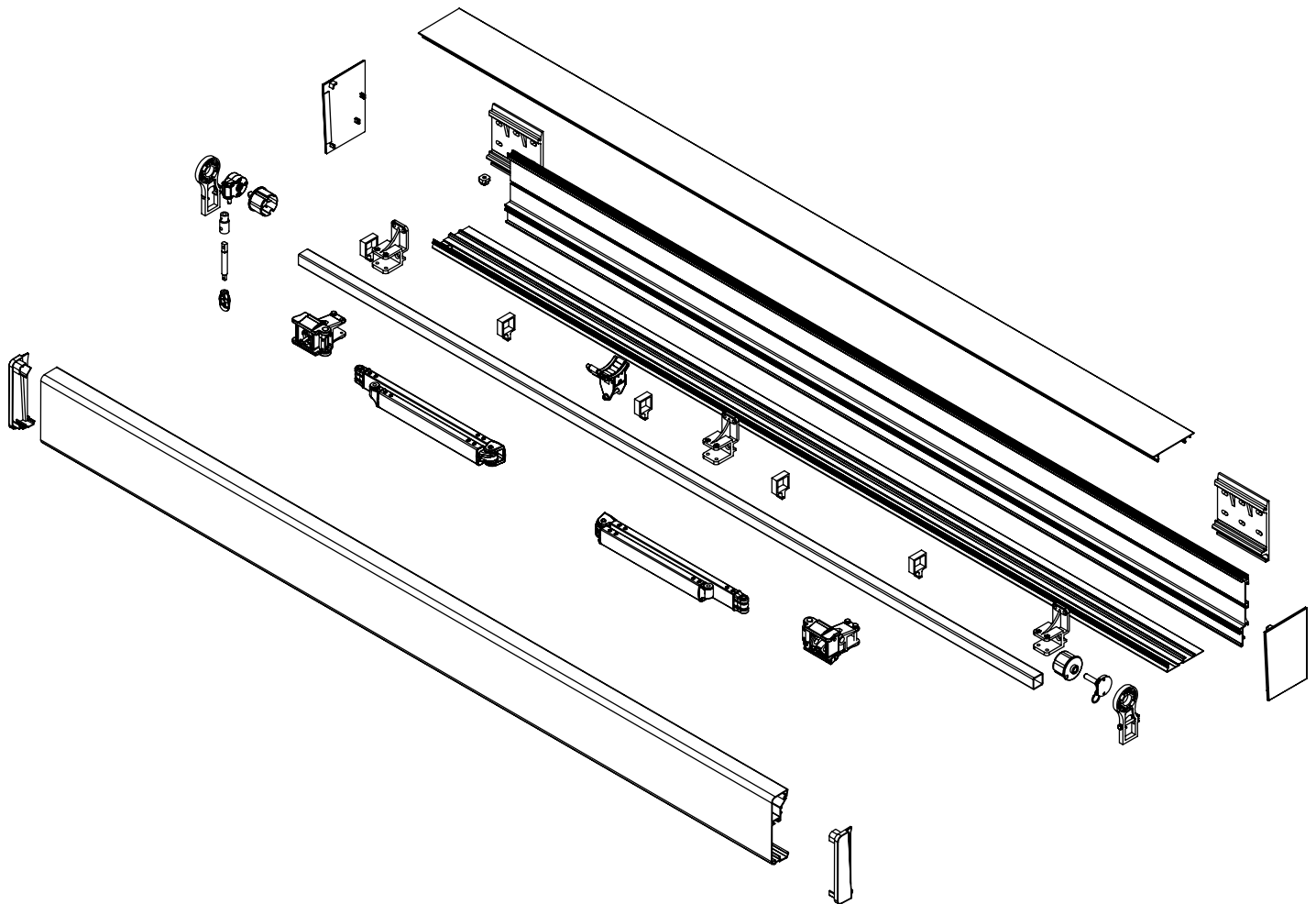

Colori di serie / Standard color / Couleurs standard



Ral
Bianco
9010

Ral
Avorio
1013

Ral
Marrone
8017

Ral
Grigio
7035

Ral
Antracite

Altri colori / Another colors / Autres couleurs +20%

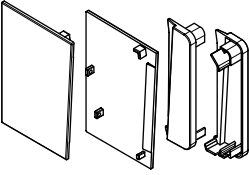
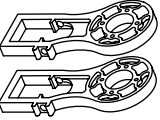
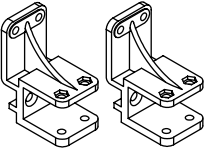
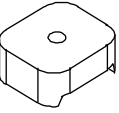
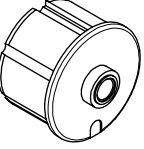
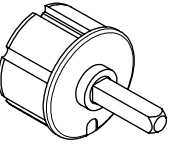
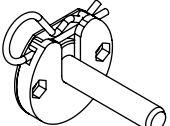
Disegno Figure Design	Descrizione Description Description	Codice Article Code Code Article	U.M. Unit	Prezzo unitario Unit price Prix unitaire	Conf. std. Std. pack Cf. std
	Arganello 11:1 Awning gearbox 11:1 Treuil 11:1	ARG11:1A	Pz		25
	Kit tappi cassonetto e terminale Kit caps with caps for terminal Profile Kit bouchons coffre et barre de charge	STBX-030	Pz		5
	Supporto parete soffitto Support wall/ceiling Support mur/plafond	STBX-005	Pz		5
	Supporto braccio star box con scivolo Support arm star box with slide Support bras star box avec goulotte	STBX-031	Cp		5
	Supporto avvolgitore star box Support winder star box Support enrouleur star box	STBX-006	Cp		5
	Supporto bq star box Support bq star box Support bq star box	STBX-008	Pz		5
	Supporto compensatore star box Star box compensator support Support de compensateur étoile	STBX-030	Pz		5
	Supporto portello star box Support star box door Support porte boîte étoile	STBX-021	Pz		5
	Fermo cass star box Star box box stop Butée de boîte étoile	STBX-007	Pz		5
	Tappo con foro Plug with hole Embout avec trou	Ø 70 TAPF70 Ø 78 TAPF78	Pz		80
	Tappo perno quadro Plug with square Embout avec axe carré	Ø 70 TAPPQ70-13x70 Ø 78 TAPPQ80-13x70	Pz		80
	Piastrina in nylon con perno estraibile Plate nylon with removable pin Plaquette en nylon avec axe extraible	PES0005	Pz		100

Disegno Figure Dessign	Descrizione Description Description	Codice Article Code Code Article	U.M. Unit	Prezzo unitario Unit price Prix unitaire	Conf. std. Std. pack Cf. std
------------------------------	---	--	--------------	--	------------------------------------

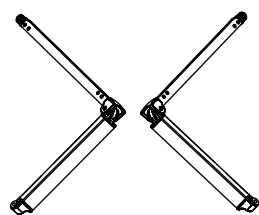

Bracci a catena
Arms with chain
Bras à chaîne

Cm 160	BRA0A160			
Cm 185	BRA0A185			
Cm 210	BRA0A210			
Cm 235	BRA0A235	Cp		10
Cm 260	BRA0A260			
Cm 285	BRA0A285			
Cm 310	BRA0A310			

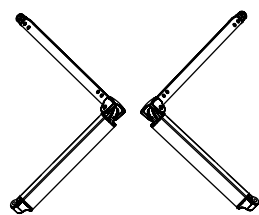

Bracci a cavetto
Arms with cable
Bras à câble

Cm 160	BQCCAV0A160			
Cm 185	BRACAV0A185			
Cm 210	BRACAV0A210			
Cm 235	BRACAV0A235	Cp		10
Cm 260	BRACAV0A260			
Cm 285	BRACAV0A285			
Cm 310	BRACAV0A310			

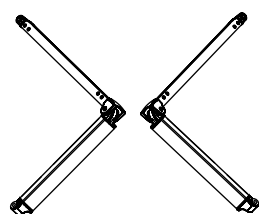

Bracci con cavetti in acciaio Rivestiti
Arms with steel wires Couted
Bras avec câble en acier recouvert

Cm 160	BRA0A160F			
Cm 185	BRA0A185F			
Cm 210	BRA0A210F			
Cm 235	BRA0A235F	Cp		10
Cm 260	BRA0A260F			
Cm 285	BRA0A285F			
Cm 310	BRA0A310F			

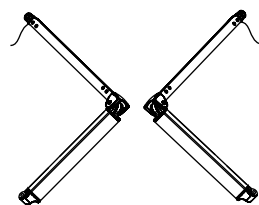

Bracci led KIRO a catena
Arms with chain
Bras à chaîne

Cm 160	BQC-LED-160A			
Cm 185	BQC-LED-185A			
Cm 210	BQC-LED-210A			
Cm 235	BQC-LED-235A	Cp		10
Cm 260	BQC-LED-260A			
Cm 285	BQC-LED-285A			
Cm 310	BQC-LED-310A			

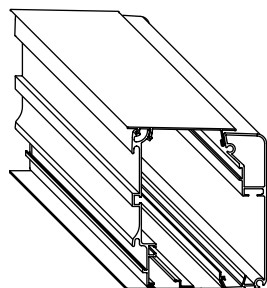

Kit profili Star Box 4 pezzi
Profiles Kit Star Box 4 pieces
Kit de profilés Star Box 4 pièces
10992gr/ml

Cm 400	KIT-STBX4A			
Cm 500	KIT-STBX5A	Pz		5
Cm 600	KIT-STBX6A			
Cm 700	KIT-STBX7A			

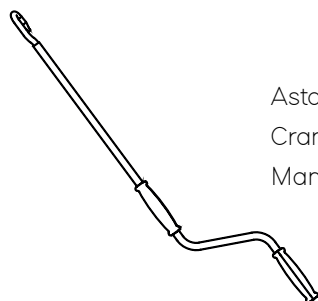

Asta di manovra verniciata
Crank handle
Manivelle

Cm 35	AST0A100			
Cm 50	AST0A120			
Cm 70	AST0A150			
Cm 90	AST0A180			
Cm 120	AST0A200	Pz		10
Cm 140	AST0A220			
Cm 250	AST0A250			
Cm 300	AST0A300			

Note

A large rectangular area with horizontal dotted lines, intended for writing notes.

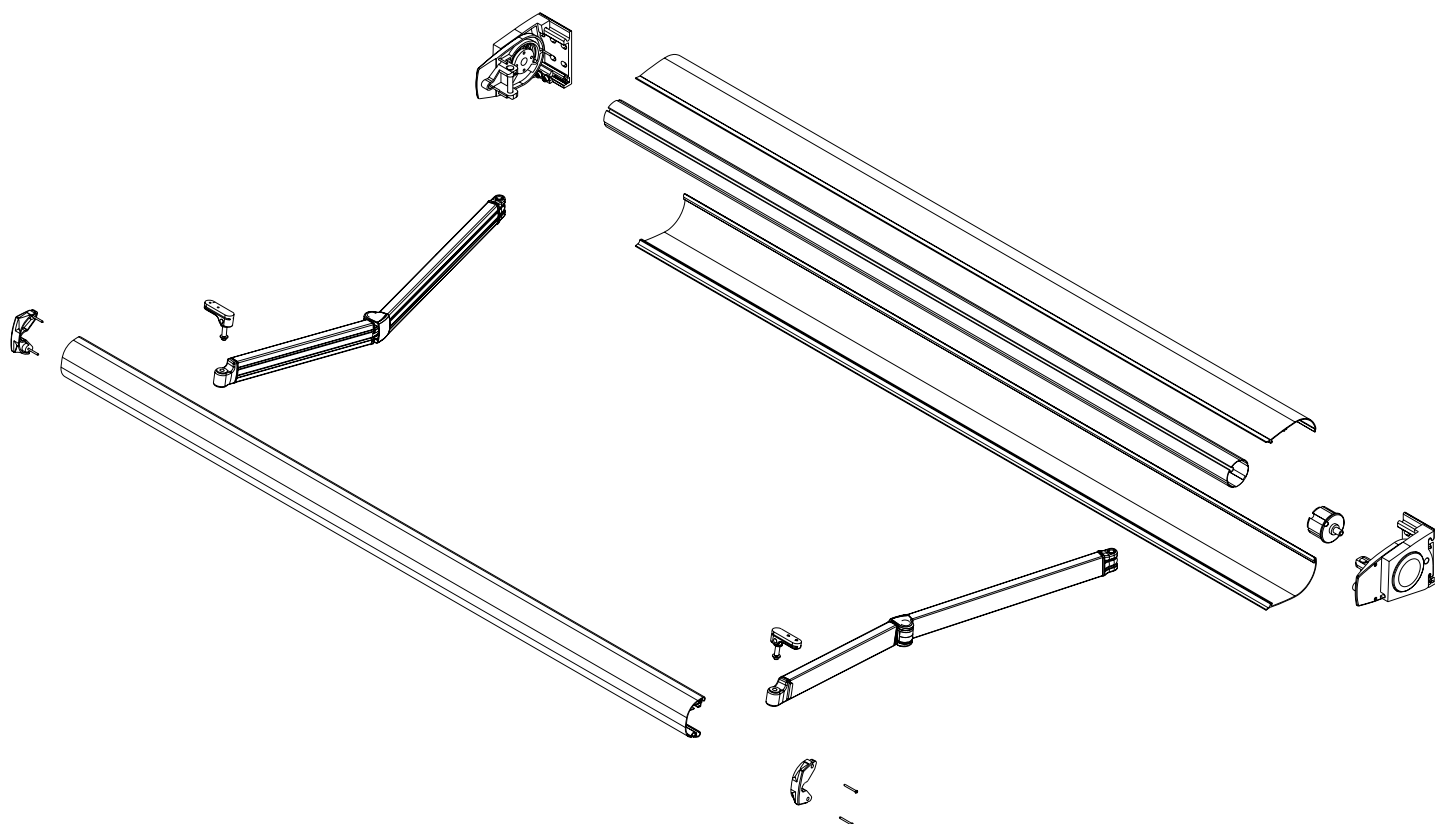

Colori di serie / Standard color / Couleurs standard



Ral
Bianco
9010

Ral
Avorio
1013

Ral
Marrone
8017

Ral
Grigio
7035

Ral
Antracite

Altri colori / Another colors / Autres couleurs +20%

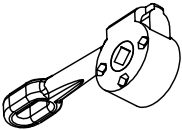
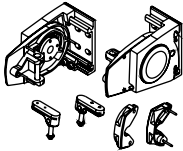
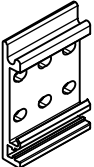
Disegno Figure Design	Descrizione Description Description	Codice Article Code Code Article	U.M. Unit	Prezzo unitario Unit price Prix unitaire	Conf. std. Std. pack Cf. std
	Arganello 11:1 Awning gearbox 11:1 Treuil 11:1	ARG11:1A	Pz	18,90	25
	Kit supporti verona parete/soffitto Kit support verona wall/ceiling Kit supports verona mur/plafond	VERO-001	Pz	140,00	5
	Supporto parete soffitto Support wall/ceiling Support mur/plafond	F430A-001	Pz	14,18	5

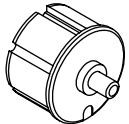
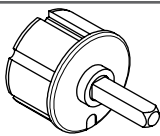
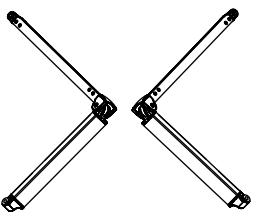
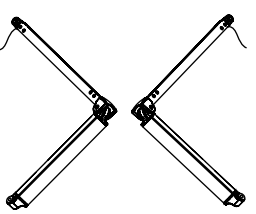
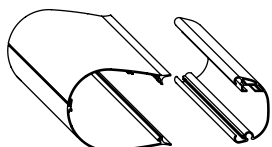
Disegno Figure Design	Descrizione Description Description		Codice Article Code Code Article	U.M. Unit	Prezzo unitario Unit price Prix unitaire	Conf. std. Std. pack Cf. std
	Tappo Con perno tondo 14x20	Ø 70	TAPPT70	Pz		80
	Plug with round pin 14x20	Ø 78	TAPPT78			
	Tappo perno quadro	Ø 70	TAPPQ70-13x70	Pz		80
	Plug with square	Ø 78	TAPPQ78-13x70			
	Supporto centrale cassonetto Central support box Boîte de support centrale		MILA-033	Pz		10
	Bracci a catena Arms with chain Bras à chaîne	Cm 160	MIL0A160	Cp		10
		Cm 185	MIL0A185			
		Cm 210	MIL0A210			
		Cm 235	MIL0A235			
		Cm 260	MIL0A260			
		Cm 285	MIL0A285			
	Bracci a cavetto Arms with cable Bras à câble	Cm 160	MIL0A160C	Cp		10
		Cm 185	MIL0A185C			
		Cm 210	MIL0A210C			
		Cm 235	MIL0A235C			
		Cm 260	MIL0A260C			
		Cm 285	MIL0A285C			
	Bracci con cavetti in acciaio Rivestiti Arms with steel wires Couted Bras avec câble en acier recouvert	Cm 160	MIL0A160F	Cp		10
		Cm 185	MIL0A185F			
		Cm 210	MIL0A210F			
		Cm 235	MIL0A235F			
		Cm 260	MIL0A260F			
		Cm 285	MIL0A285F			
	Bracci led KIRO a catena Arms with chain Bras à chaîne	Cm 160	KIRO-LED-160A	Cp		10
		Cm 185	KIRO-LED-185A			
		Cm 210	KIRO-LED-210A			
		Cm 235	KIRO-LED-235A			
		Cm 260	KIRO-LED-260A			
		Cm 285	KIRO-LED-285A			
	Kit profili verona	Cm 300	ML3A001	Pz		5
	Kit profiles verona	Cm 400	ML4A001			
	Kit profils verona	Cm 500	ML5A001			

4353gr/ml

CAPPOTTINE



Elba / Capri



Giglio

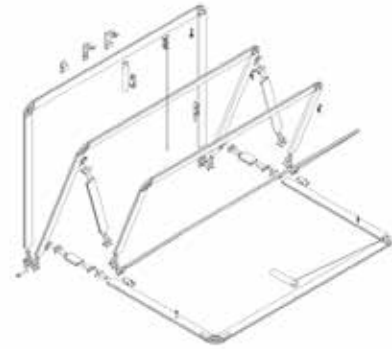

Piramide

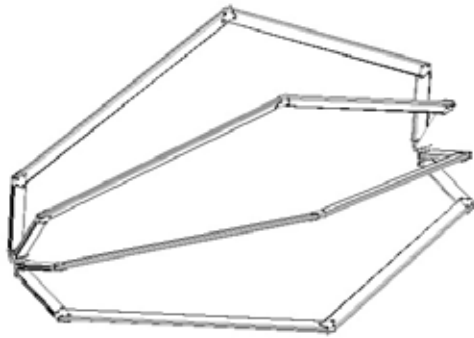

Ischia

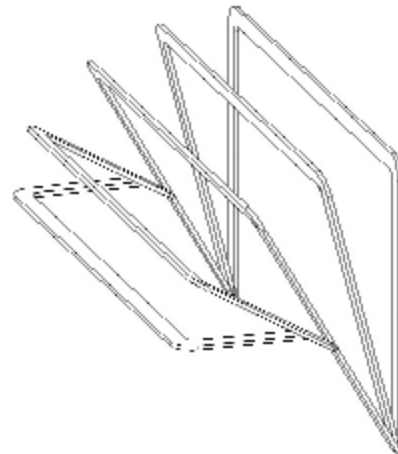

Layla

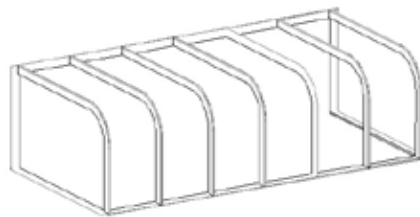

Colori di serie / Standard color / Couleurs standard



Ral Bianco 9010	Ral Verde 6005	Ral Avorio 1013	Ral Marrone 8017	Ral Grigio 7035
Ral Antracite	Ral Bronzo	Ral Nero opaco 9005	Ral Argento 9006	

Altri colori / Another colors / Autres couleurs +20%

Colori di serie / Standard color / Couleurs standard

Mod. Capri



Ral Bianco 9010	Ral Avorio 1013
-----------------------	-----------------------

Altri colori / Another colors / Autres couleurs +20%

CAPPOTTINE



Rotonda mod. A

Rotonda mod. B

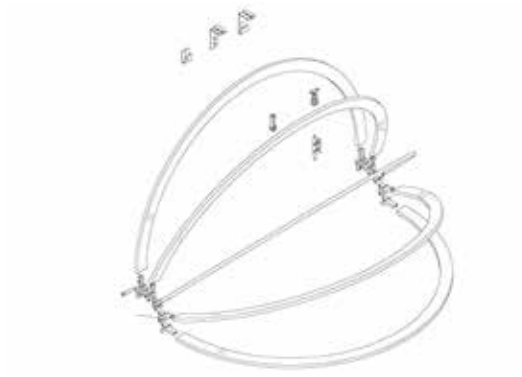
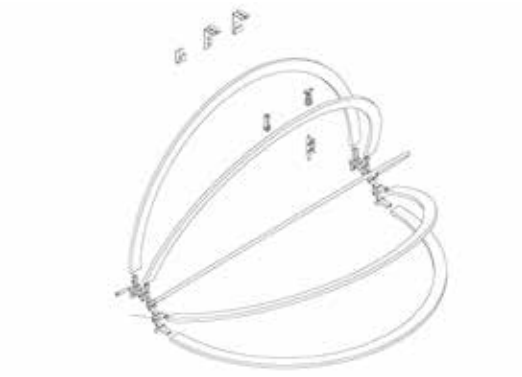

Tr fissa mod. A

Tr fissa mod. b

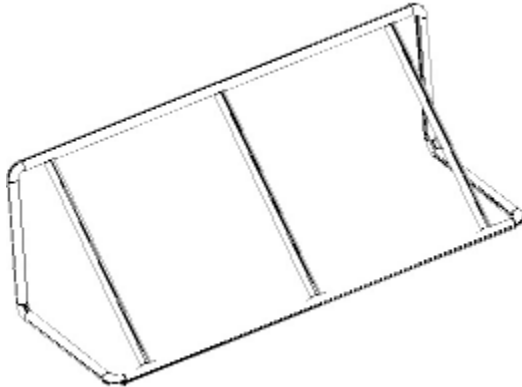
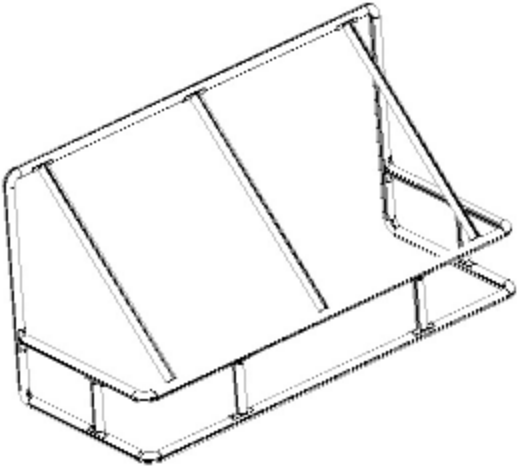

Colori di serie / Standard color / Couleurs standard





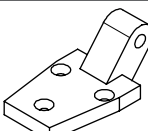

Ral Bianco 9010	Ral Verde 6005	Ral Avorio 1013	Ral Marrone 8017	Ral Grigio 7035
Ral Bronzo	Ral Nero opaco 9005	Ral Argento 9006		

Altri colori / Another colors / Autres couleurs +20%

Disegno Figure Dessign	Descrizione Description Description		Codice Article Code Code Article	U.M. Unit	Prezzo unitario Unit price Prix unitaire	Conf. std. Std. pack Cf. std
	Curva 90° (composta da 2 pz.) Curve 90° (composed of 2 pcs) Courbe 90° (compose par 2 piece)	Alluminio	CAP0A001/1	Pz		200
	Inserto in pvc per curve Insert bracket pvc for curves Insert en pvc pour courbes	PVC	CAP0A027	Pz		100
	Cerniera terminale maschio Terminal hinge male Charnière terminale mâle	Alluminio	CAP0A002/1	Pz		200
	Cerniera intermedia maschio-femmina Hinge intermediate male-female Charnière intermediaire mâle-femelle	Alluminio	CAP0A003/1	Pz		200
	Cerniera terminale femmina Terminal hinge female Charnière terminale femelle	Alluminio	CAP0A004/1	Pz		200
	Cerniera battuta parete Hinge bar wall Charnière battue mural	Alluminio	CAP0A005/1	Pz		200
	Cerniera battuta maschio Hinge bar male Charnière battue mâle	Alluminio	CAP0A006/1	Pz		200
	Ribattino per cerniera Rivet hinge Rivet pour charnière	Zincato Nylon	CAP00014 CAP0A014	Pz		100
	Carrucola grande fissa Large pulley fixed Grande poulie fixe	Nylon	CAP0A007	Pz		200
	Carrucola snodata Swivel pulley Poulie à rotule	Inox Nylon	CAP0A008/1 CAP0A008	Pz		200
	Carrucola piccola per raggiera Small pulley for rays Petite poulie pour rayon	Nylon	CAP0A009	Pz		200
	Fermacorda Rope stops Arrêt-corde	Nylon	CAP0A015	Pz		200
	Maniglia avvolgicorda Handle wrap rope Taquet pour enroulage corde	Nylon	CAP0A010	Pz		100

Disegno Figure Design	Descrizione Description Description		Codice Article Code Code Article	U.M. Unit	Prezzo unitario Unit price Prix unitaire	Conf. std. Std. pack Cf. std
	Supporto a "U" Support a "U" Support à "U"		CAP0A011	Pz		200
	Supporto a "U" rinforzato per soffitto Regolabile Support a "U" adjustable reinforced For ceiling with bolt Support à "U" renforcé pour plafond réglable		CAP0A012	Pz		50
	Staffa a "L" regolabile Bracket a "L" adjustable Support à "L" réglable		CAP0A039	Pz		50
	Giunto angolare Coupling angular Jonction angulaire		CAP0A019	Pz		50
	Giunto a "T" Insert bracket a "T" Support à "T"		CAP0A038	Pz		50
	Curva in per profilo 15x45 Curve for profile 15x45 Courbe pour profil 15x45	Nylon	CAP0A036	Pz		50
	Cerniera 4 raggi profilo 15x45 Hinge 4 rays for profile 15x45 Charnière 4 rayons profil 15x45	Nylon	CAP0A040	Pz		20
	Cerniera 5 raggi profilo 15x45 Hinge 5 rays for profile 15x45 Charnière 5 rayons profil 15x45	Nylon	CAP0037	Pz		20
	Cerniera 4 raggi elba Hinge 4 rays for elba Charnière 4 rayons elba	Alluminio	CAP00031	Pz		10
	Cerniera 5 raggi elba Hinge 5 rays for elba Charnière 5 rayons elba	Alluminio	CAP0A033	Pz		10
	Curva regolabile per profilo 14,4x50 Adjustable curve for profile 14,4x50 Courbe réglable pour profil 14,4,x50	Alluminio	CAP00036A	Pz		10
	Tappo per profilo cappottina Caps for profile cappottina Bouchons pour profil cappottina	Nylon	CAP00037	Pz		20
	Tappo per profilo rinforzato cappottina Plug for profile reinforced cappottina Bouchon pour profil renforcé	Nylon	CAP0A030	Pz		20

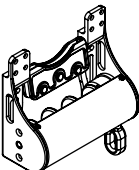
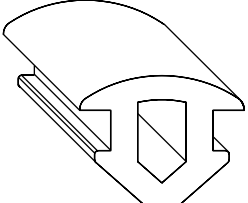
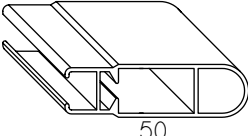
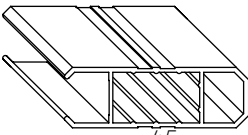
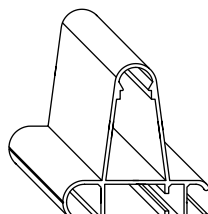
Disegno Figure Dessign	Descrizione Description Description		Codice Article Code Code Article	U.M. Unit	Prezzo unitario Unit price Prix unitaire	Conf. std. Std. pack Cf. std
	Kit accessori capri 4 raggi Kit accessories capri 4 rays Kit accessoires capri 4 rayons		KITCR4R001			
	Kit accessori capri 5 raggi Kit accessories capri 5 rays Kit accessoires capri 5 rayons	Nylon	KITCR5R001	Pz		5
	Kit accessori elba 4 raggi Kit accessories elba 4 rays Kit accessoires elba 4 rayons		KITCA4R001			
	Kit accessori elba 5 raggi Kit accessories elba 5 rays Kit accessoires elba 5 rayons	Alluminio	KITCA5R001	Pz		5
	Kit accessori giglio 4 raggi Kit accessories giglio 4 rays Kit accessoires giglio 4 rayons		KITGE4R001			
	Kit accessori giglio 5 raggi Kit accessories giglio 5 rays Kit accessoires giglio 5 rayons	Alluminio	KITGE5R001	Pz		5
	Kit accessori ischia 4 raggi Kit accessories ischia 4 rays Kit accessoires ischia 4 rayons		KITLO4R001			
	Kit accessori ischia 5 raggi Kit accessories ischia 5 rays Kit accessoires ischia 5 rayons	Alluminio	KITLO5R001	Pz		5
	Kit arganello per cappottina Kit awning gearbox for cappottina Kit treuil pour store corbeille		CAP0A017	Pz		5
	ESCLUSO ASTA DI MANOVRA - WITH OUT CRANK HANDLE - SANS MANIVELLE					
	Guarnizione x profilo 14,4x50 elba Profile pvc for finish 14,4x50 elba Joint pour profil 14,4x50 elba		CAP00021			
	Guarnizione x profilo 15x45 capri Profile pvc for finish 15x45 capri Joint pour profil 15x45 capri		CAP0A023	MI		150
	Profilo principale 14,4x50 Profile basic 14,4x50 Profil principal 14,4x50		Cm 700	CAP7A024	Pz	10
		441gr/ml				
	Profilo cappottina capri 15x45 Profile cappottina capri 15x45 Profil capri 15x45		Cm 700	CAP7A041	Pz	10
		397gr/ml				
	Profilo rinforzato Profile reinforced Profil renforcé		Cm 700	CAP7A029	Pz	10
		871gr/ml				

Note

A large rectangular area with horizontal dotted lines, intended for writing notes.



Tipo-Type A

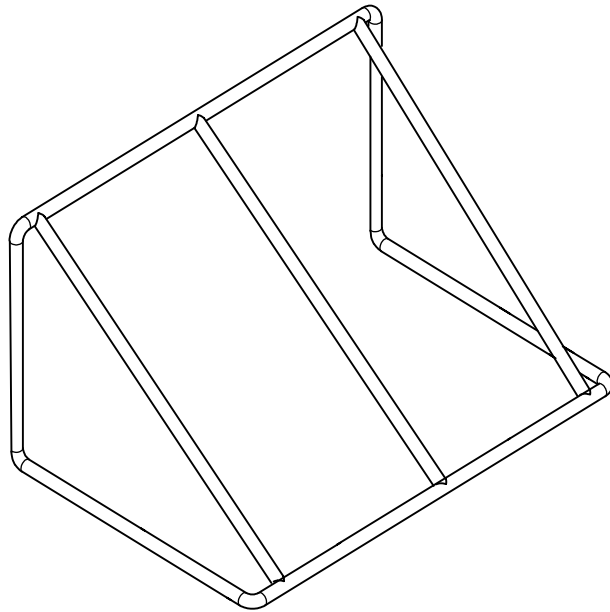

Tipo-Type B

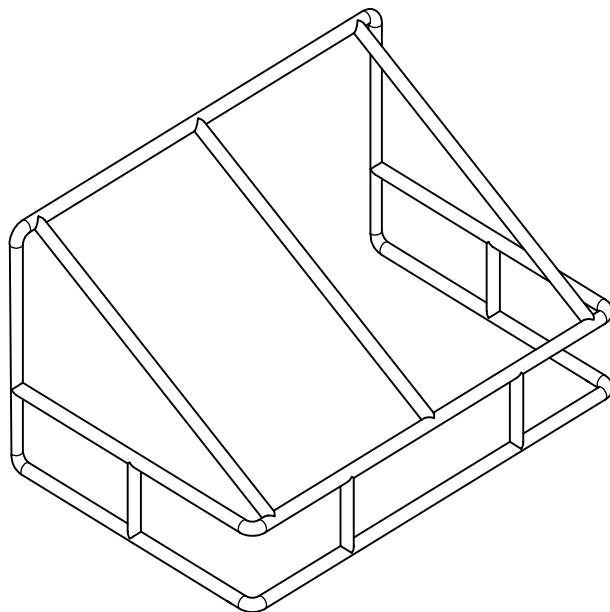

Colori di serie / Standard color / Couleurs standard



Ral
Bianco
9010

Altri colori / Another colors / Autres couleurs +20%

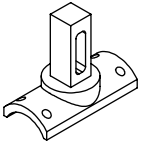
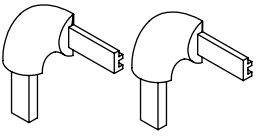
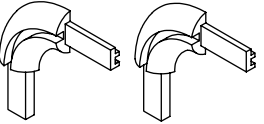
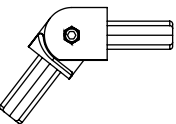
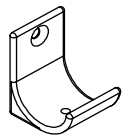
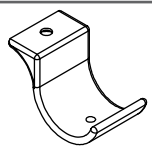
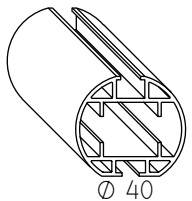
Disegno Figure Design	Descrizione Description Description	Codice Article Code Code Article	U.M. Unit	Prezzo unitario Unit price Prix unitaire	Conf. std. Std. pack Cf. std
	Supporto a "T" Asia Support a "T" Asia Support à "T" Asia	AM0A001	Pz		10
	Curva asia (composta da 2 pz) Curve asia (composed of 2 pcs) Courbe asia (composé de 2 pièces)	AM0A002	Pz		10
	Curva con scanalatura asia Support for wall asia Courbe avec rainure asia	AM0A006	Pz		10
	Curva snodata asia Jointed curve asia Courbe articulée asia	ASIA 017	Pz		10
	Supporto a parete asia Support for wall asia Support mural asia	AM0A003	Pz		10
	Supporto a soffitto asia Support for ceiling asia Support plafond asia	AM0A004	Pz		50
	Terminale 31266 Terminal profile 31266 Barre de charge 31266 793gr/ml	Cm 400 GALL4A003 Cm 500 GALL5A003 Cm 600 GALL6A003 Cm 700 GALL7A003	MI		10

ECO TUNNEL

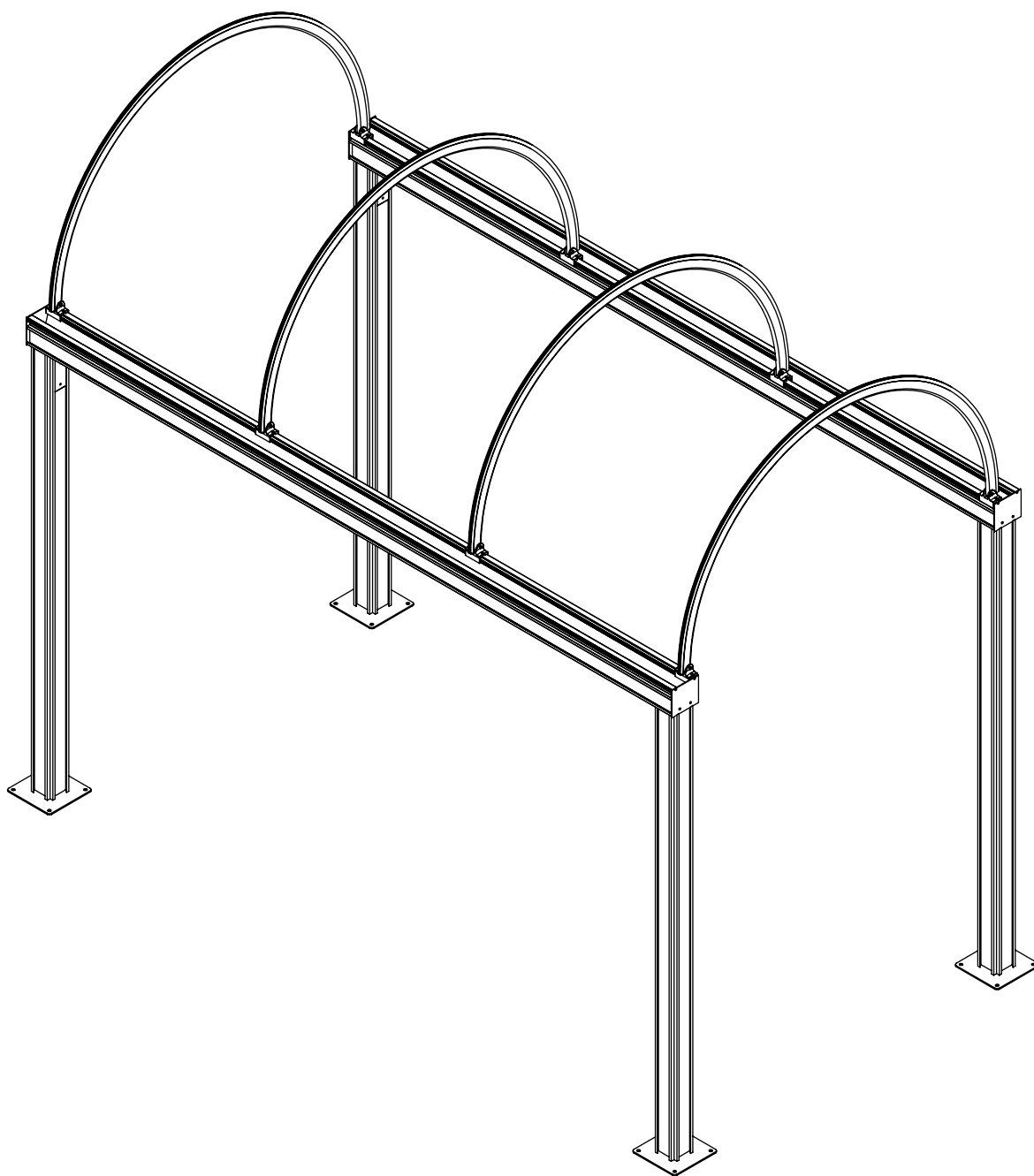





Colori di serie / Standard color / Couleurs standard

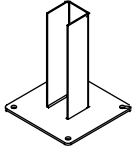
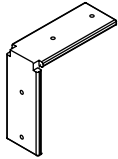
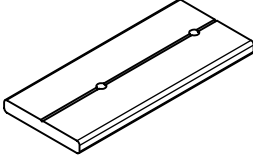

Ral
Bianco
9010

Altri colori / Another colors / Autres couleurs +20%

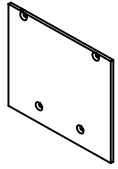
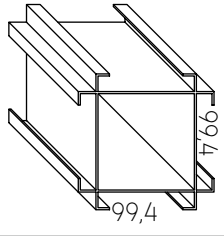
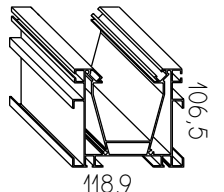
Disegno Figure Design	Descrizione Description Description	Codice Article Code Code Article	U.M. Unit	Prezzo unitario Unit price Prix unitaire	Conf. std. Std. pack Cf. std
	Piede tunnel Leg eco tunel Pied tunnel	GALL0A010	Pz		4
	Staffa 90° 170x170 Bracket 90° 170x170 Support 90° 170x170	GALL0A007	Pz		8
	Giunzione profilo portante Junction carrier profile Jonction profil principal	GALL0A005	Pz		8
	Supporto centina fisso Support center fixed Support courbe fixe	EGALL0A002	Pz		50
	Supporto centina regolabile Support center adjustable Support courbe réglable	EGALL0A003	Pz		20
	Gancio laterale girevole Side hook gazebo tent Crochet pour gazebo	GAZ00014	Pz		40
	Carrello scorrevole per binario in Alluminio Sliding trolley for track allum. Chariot coulissant pour rail en aluminium Carrello scorrevole per profilo Gazebo Sliding trolley for track gazebo Chariot coulissant pour profil gazebo	GAZ00055 GAZ00056	ML		100
	Tappo canala Cap canal eco tunnel Bouchon gouttière	GALL0A008	Pz		20
	Profilo colonna Profile column Profil jambe 2180gr/ml	Cm 400 GALL4A001 Cm 500 GALL5A001 Cm 600 GALL6A001 Cm 700 GALL7A001	Pz		10
	Profilo portante piccolo Profil carrier small Profil principal 1717gr/ml	Cm 400 GALL4A002 Cm 500 GALL5A002 Cm 600 GALL6A002 Cm 700 GALL7A002	Pz		10

SCREENS

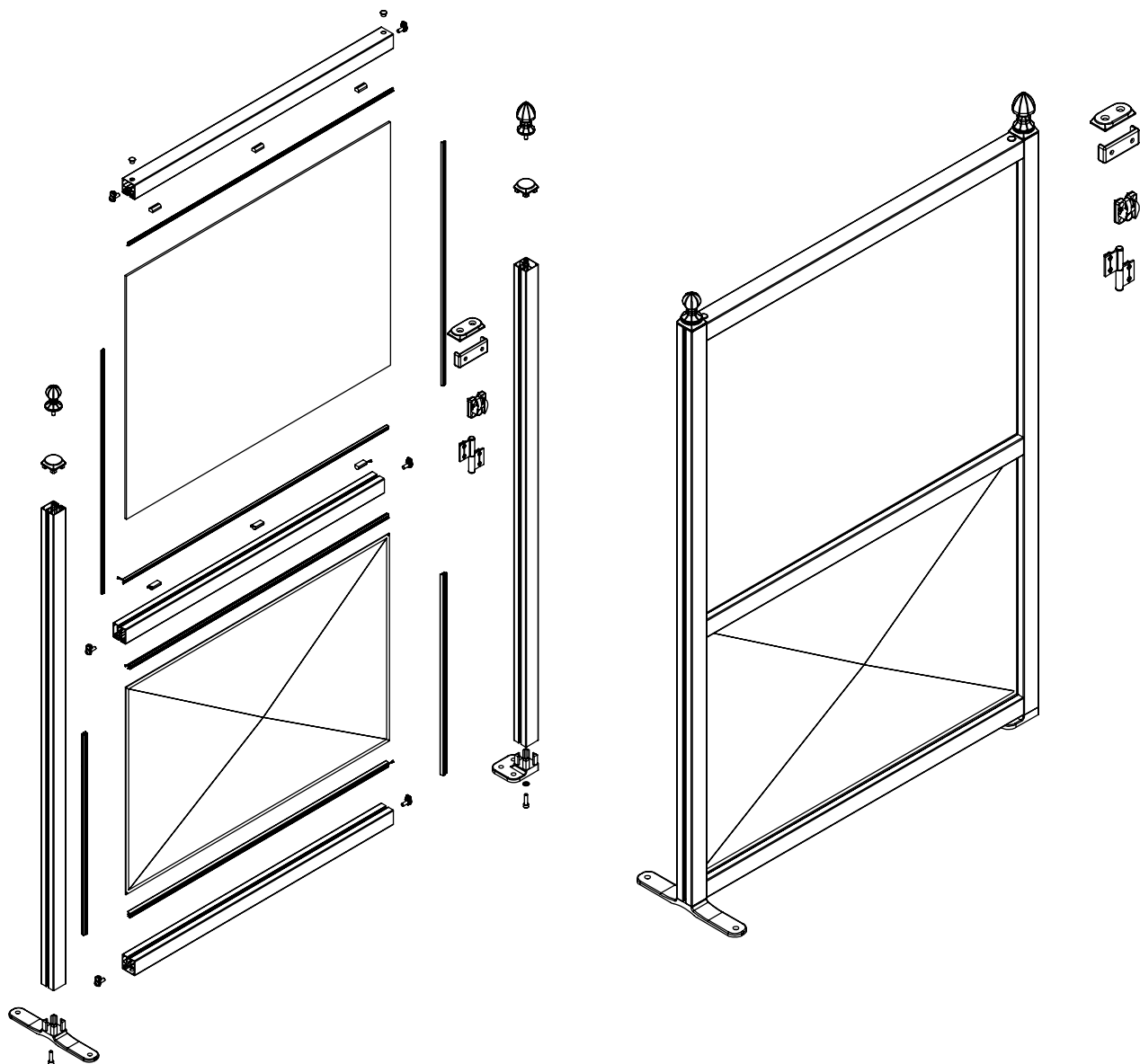





Colori di serie / Standard color / Couleurs standard

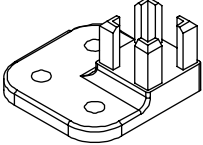
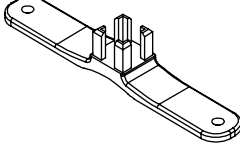
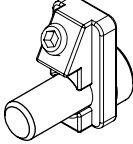
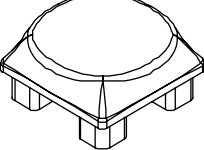
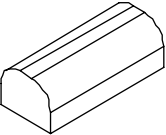

Ral
Antracite

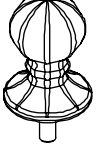
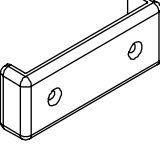
Altri colori / Another colors / Autres couleurs +20%

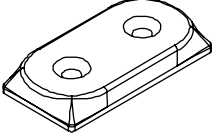
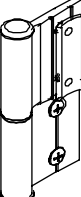
Disegno Figure Design	Descrizione Description Description	Codice Article Code Code Article	U.M. Unit	Prezzo unitario Unit price Prix unitaire	Conf. std. Std. pack Cf. std
	Piedino Leg Pied	SCRE-001	Pz		10
	Piede autoportante Leg self-supporting Pied auto-supportant	SCRE-005	Pz		10
	Fermo completo Bracket fixed kit Arrêt complet	SCRE-004	Pz		10
	Tappo Cap Bouchon	SCRE-002	Pz		10
	Spessore per vetro Thicknes for glass Epaisseur pour verre	SCRE-006	Pz		50
	Punta Tip Pointe	SCRE-007	Pz		10
	Palla Ball Boule	SCRE-008	Pz		10
	Staffa doppio modulo Double bracket form Support double module	SCRE-019	Pz		10
	Tappino Cap mini Bouchon	MILA-18	Pz		50
	Tappo modulo doppio Cap double module Bouchon double module	SCRE-018	Pz		10
	Cerniera Hinge Charnière	SCRE-036	Pz		50

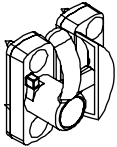
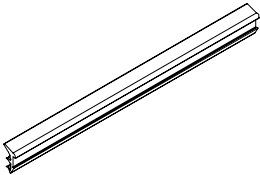
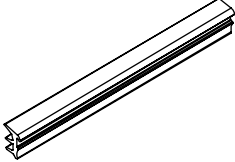
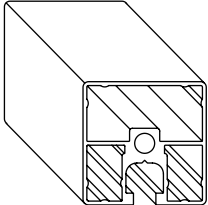
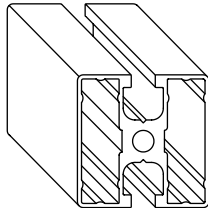
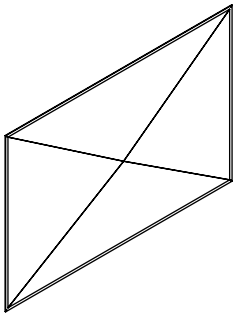
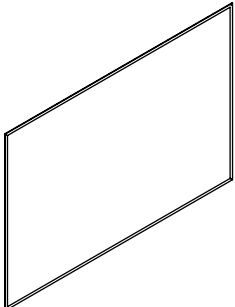
Disegno Figure Dessign	Descrizione Description Description	Codice Article Code Code Article	U.M. Unit	Prezzo unitario Unit price Prix unitaire	Conf. std. Std. pack Cf. std
	Catenaccio Latch Latch	SCRE-028	Pz		10
	Guarnizione vetro mm.2 Glass gasket mm2 Joint verre 2 mm	GUARMM2	MI		400
	Guarnizione policarbonato mm.4 Polycarbonate gasket mm4 Joint de polycarbonate mm.4	GUARMM4			250
	Guarnizione pannello mm.7 Panel gasket mm7 Joint panneau 7 mm	GUARMM7	MI		125
	Profilo 1 gola Profile with 1 gorge Profil avec 1 gorge	SCRE-011	MI		10
				1336gr/ml	
	Profilo 2 gole Profile with 2 gorges Profil avec 2 gorges	SCRE-010	MI		10
				1509gr/ml	
	Pannello in lamiera zincata verniciata I.50Xh.65 Panel sheet zinc painted I.50Xh.65 Panneau en tole galvanisée I.50Xh.65	PAN-ZINC50	MI		5
	Pannello in lamiera zincata verniciata I.100Xh.66 Panel sheet zinc painted I.100Xh.66 Panneau en tole galvanisée I.100Xh.66	PAN-ZINC100			
	Pannello in alluminio I.50Xh.65 Allum. Panel I.50Xh.65 Panneau en aluminium I.50Xh.65	Cm 500 PAN-ALL50	MI		5
	Pannello in alluminio I.100Xh.65 Allum. Panel I.100Xh.65 Panneau en aluminium I.100Xh.65	Cm 700 PAN-ALL100			

Note

A large rectangular area with horizontal dotted lines, intended for writing notes.

VETRATA SCORREVOLE

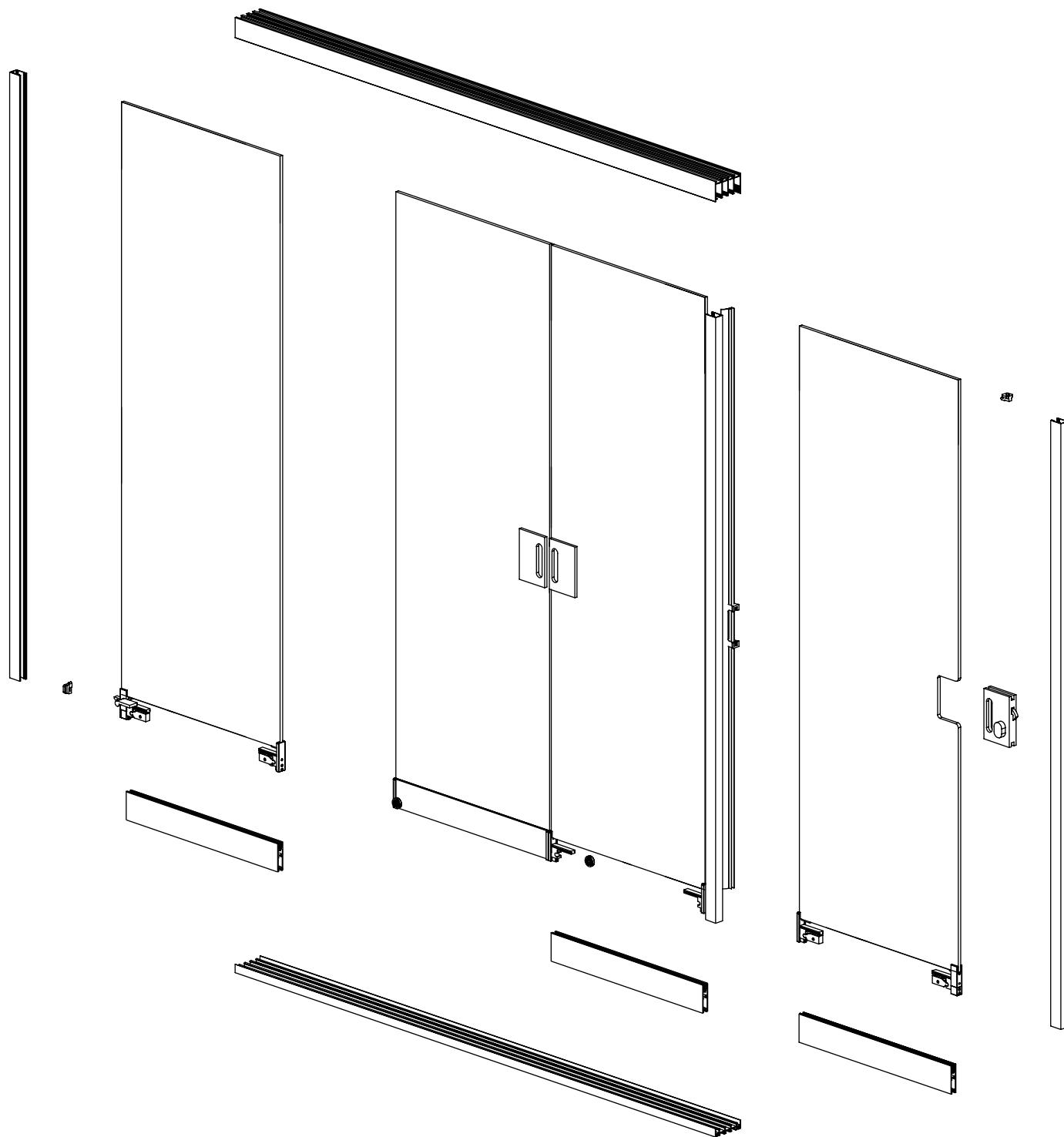

Colori di serie / Standard color / Couleurs standard



Ral	Ral	Ral
Bianco	Avorio	Marrone
9010	1013	8017

Ral	Ral
Antracite	Corten

Altri colori / Another colors / Autres couleurs +20%

Disegno Figure Design	Descrizione Description Description	Codice Article Code Code Article	U.M. Unit	Prezzo unitario Unit price Prix unitaire	Conf. std. Std. pack Cf. std
	Carrello scorrevole intermedio Intermediate sliding trolley Chariot coulissant intermédiaire	VETR-017	Pz		
	Carrello scorrevole con gancio dx Sliding trolley with right hook Chariot coulissant avec crochet droit	VETR-018	Pz		
	Carrello scorrevole laterale Side sliding trolley Chariot latéral coulissant	VETR-025	Pz		
	Carrello scorrevole con gancio sx Sliding trolley with left hook Chariot coulissant avec crochet gauche	VETR-024	Pz		10
	Kit fermavetro Glass retainer kit Kit de retenue de verre	VETR-026	Pz		50
	Kit aggancio vetro Glass coupling kit Kit de couplage de verre	VETR-027	Pz		10
	Kit aggancio serratura laterale Side lock coupling kit Kit d'accouplement à verrouillage latéral	VETR-028	Pz		10
	Spessore 3 vie 3 way thickness Épaisseur 3 voies	VETR-012	Pz		10
	Attacco spessore 3 vie 3 ways thickness connection Connexion à 3 épaisseurs	VETR-013	Pz		50
	Spessore 4 vie 4 way thickness Épaisseur 4 voies	VETR-014	Pz		10
	Attacco spessore 4 vie 4 ways thickness connection Connexion à 4 épaisseurs	VETR-015	Pz		50

Disegno Figure Dessign	Descrizione Description Description		Codice Article Code Code Article	U.M. Unit Unit	Prezzo unitario Unit price Prix unitaire	Conf. std. Std. pack Cf. std
	Serratura con chiave Lock with key Serrure avec clé		Inox GHSL1N	Pz		1
	Controcattella serratura Lock counterfolder Verrouiller le contre-dossier		Inox GHSL2N	Pz		1
	Anello chiuso Closed loop Boucle fermée		Inox RH1	Pz		1
	Spazzolino tcl mm 11 Brush tcl mm 11 Brosse tcl mm 11		TCL-016	MI		650
	Guarnizione con aletta Seal with flap Joint avec rabat		VAI37	MI		10
	Guarnizione a palloncino Balloon seal Joint de ballon		VAI35	MI		5
	Guida soffitto 4 vie 4-way ceiling guide Guide de plafond à 4 voies	2502gr/ml	CM 700 VETR7A003	MI		10
	Guida a terra 4 vie 4-way ground guide Guide au sol à 4 voies	1461gr/ml	CM 700 VETR7A004	MI		10
	Guida soffitto 3 vie 3-way ground guide Guide au sol à 3 voies	1997gr/ml	CM 700 VETR7A006	MI		10
	Guida a terra 3 vie 3-way ground guide Guide au sol à 3 voies	1175gr/ml	CM 700 VETR7A005	MI		10
	Profilo vetro Glass profile Profil en verre	1223gr/ml	CM 700 VETR7A002	MI		10
	Profilo a "U" "U" profile Profil "U"	491gr/ml	CM 700 VETR7A001	MI		10

Note

A large rectangular area with horizontal dotted lines, intended for writing notes.

VETRATA SALISCENDI

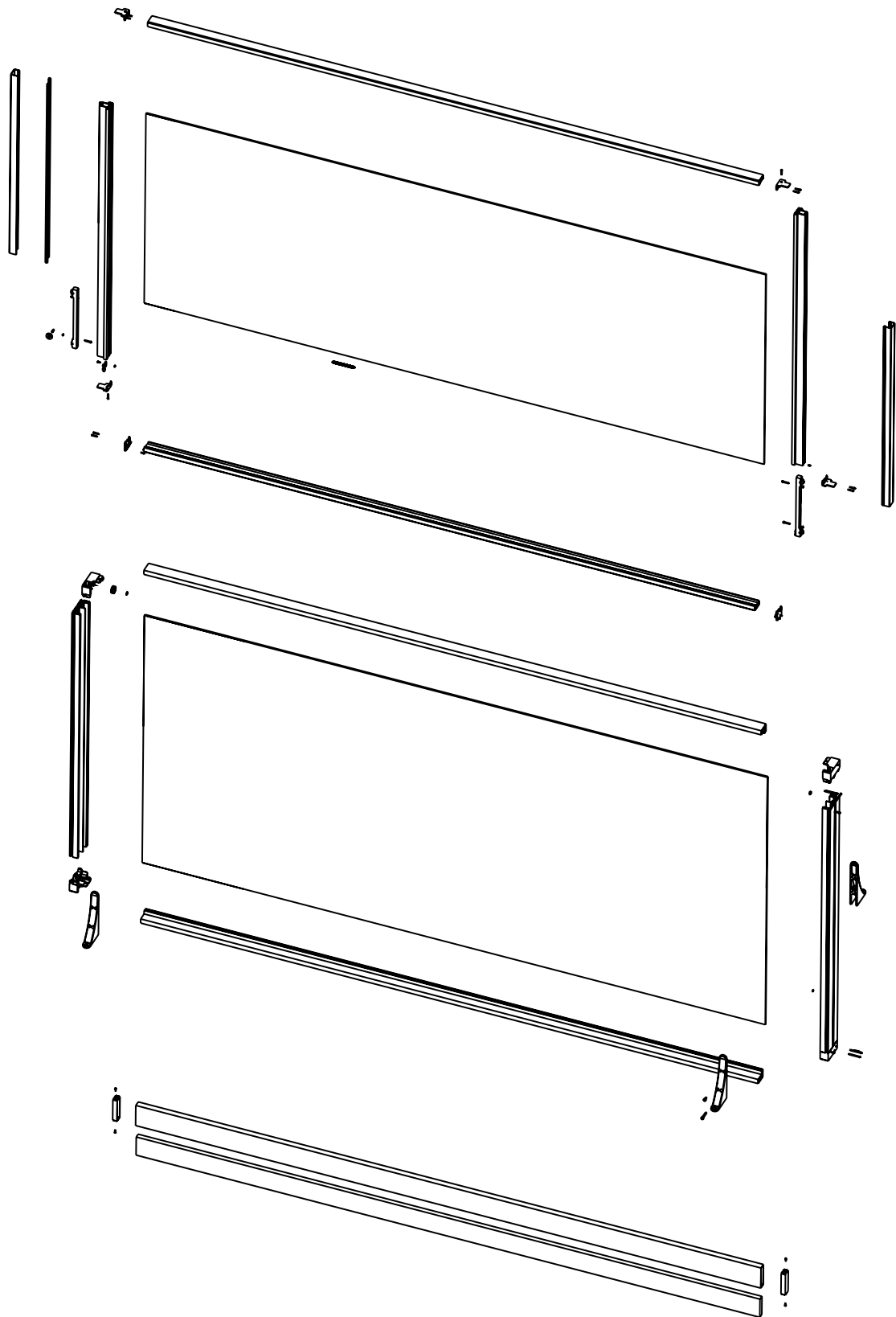

Colori di serie / Standard color / Couleurs standard



Ral	Ral	Ral
Bianco	Avorio	Marrone
9010	1013	8017

Ral	Ral
Antracite	Corten

Altri colori / Another colors / Autres couleurs +20%

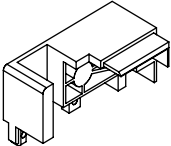
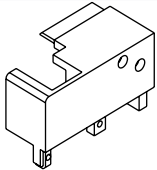
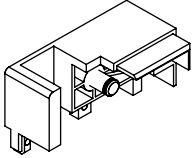
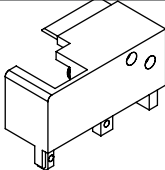
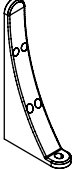
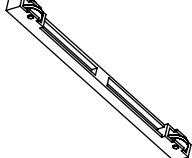
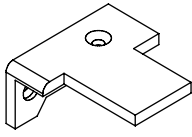
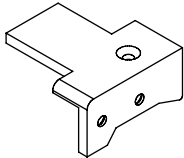
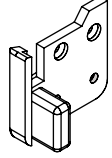
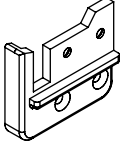
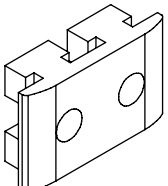
Disegno Figure Design	Descrizione Description Description	Codice Article Code Code Article	U.M. Unit	Prezzo unitario Unit price Prix unitaire	Conf. std. Std. pack Cf. std
	Tappo profilo verticale fisso sx Left fixed vertical profile cap Capuchon de profil vertical fixe gauche	VTSZ-018	Pz		
	Tappo profilo verticale fisso dx Fixed right vertical profile cap Capuchon de profil vertical droit fixe	VTSZ-016	Pz		
	Tappo con perno dx Plug with right pin Fiche avec broche droite	VTSZ-022	Pz		
	Tappo con perno sx Sliding trolley with left hook Capuchon avec goupille gauche	VTSZ-021	Pz		
	Piede vetrata saliscendi Up and down glazed feet Pieds vitrés de haut en bas	VTSZ-015	Pz		
	Carrello vetrata saliscendi Up and down glazed trolley Chariot vitré haut et bas	VTSZ-001	Pz		
	Tappo prof mobile superiore dx Upper right mobile prof Prof mobile supérieur droit	VTSZ-006	Pz		
	Tappo prof mobile superiore sx Upper left mobile prof Prof mobile supérieur gauche	VTSZ-005	Pz		
	Tappo profilo mobile inferiore dx Lower right mobile profile cap Capuchon de profil mobile inférieur droit	VTSZ-012	Pz		
	Tappo profilo mobile inferiore sx Lower left mobile profile cap Capuchon de profil mobile inférieur gauche	VTSZ-017	Pz		
	Staffa centrale Central bracket Support central	VTSZ-014	Pz		

Disegno Figure Dessign	Descrizione Description Description		Codice Article Code Code Article	U.M. Unit	Prezzo unitario Unit price Prix unitaire	Conf. std. Std. pack Cf. std
	Ferma corda Cord stop Arrêt de cordon		VTSZ-013	Pz		10
	L per ferma corda L for stop rope L pour stop rope		VTSZ-009	MI		400
	Staffa angolare Angular bracket Support angulaire		VTSZ-011	MI		125
	Tappo angolare Angular cap Capuchon angulaire		VTSZ-020	MI		10
	Profilo laterale fisso Fixed side profile Profil latéral fixe	1730gr/ml	Cm 500 SPRDISE0176	MI		10
	Profilo orizzontale Horizontal profile Profil horizontal	1007gr/ml	Cm 500 SPRDISE0177-5 Cm 700 SPRDISE0177-7	MI MI		10 10
	Profilo laterale mobile Movable side profile Profil latéral mobile	1050gr/ml	Cm 600 SPRDISE0180	MI		10
	Profilo orizzontale mobile Mobile horizontal profile Profil horizontal mobile	853gr/ml	Cm 500 SPRDISE0179-5 Cm 700 SPRDISE0179-7	MI MI		10 10
	Profilo porta zavorra Ballast holder profile Profil de support de ballast	827gr/ml	Cm 500 SPRDISE0178-5 Cm 700 SPRDISE0178-7	MI MI		10 10
	Spazzolino tcl mm 9 Brush tcl mm 11 Brosse tcl mm 11		TCL-017	MI		650
	Profilo angolare Angular profile Profil angulaire	976gr/ml	Cm 500 SPRDISE0181-5 Cm 600 SPRDISE0181-6	MI MI		10 10

Note

A large rectangular area with horizontal dotted lines, intended for writing notes.

CALOTTE/PLUGS/ EMBOUTS

Disegno Figure	Descrizione Description		Codice Article Code	U.M. Unit	Prezzo unitario Unit price 	Conf. std. Std. pack
	Calotta con foro \varnothing 14 Plug with hole \varnothing 14 Embout avec trou \varnothing 14	\varnothing 40	TAPF40			
		\varnothing 50	TAPF50			
		\varnothing 60	TAPF60	Pz		200
		\varnothing 70	TAPF70			
		\varnothing 80	TAPF80			
	Calotta \varnothing 60 perno tondo Plug with round pin \varnothing 60 Embout \varnothing 60 avec axe rond	14x20	TAPPT60			80
		12x20	TAPPT60-1	Pz		
	Calotta \varnothing 70 perno tondo Plug with round pin \varnothing 70 Embout \varnothing 70 avec axe rond	14x20	TAPPT70			80
		12x20	TAPPT70-1	Pz		
	Calotta \varnothing 78 perno tondo Plug with round pin \varnothing 78 Embout \varnothing 78 avec axe rond	14x20	TAPPT78			60
		12x20	TAPPT78-1	Pz		
	Calotta \varnothing 60 perno quadro Plug with square pin \varnothing 60 Embout \varnothing 60 avec axe carré	13x25	TAPPQ60-13x25			
		13x40	TAPPQ60-13x40			
		13x48	TAPPQ60-13x48	Pz		80
		13x55	TAPPQ60-13x55			
		13x70	TAPPQ60-13x70			
	Calotta \varnothing 70 perno quadro Plug with square pin \varnothing 70 Embout \varnothing 70 avec axe carré	13x25	TAPPQ70-13x25			
		13x40	TAPPQ70-13x40			
		13x48	TAPPQ70-13x48	Pz		80
		13x55	TAPPQ70-13x55			
		13x70	TAPPQ70-13x70			
	Calotta \varnothing 78 perno quadro Plug with square pin \varnothing 78 Embout \varnothing 78 avec axe carré	13x25	TAPPQ78-13x25			
		13x40	TAPPQ78-13x40			
		13x48	TAPPQ78-13x48	Pz		80
		13x55	TAPPQ78-13x55			
		13x70	TAPPQ78-13x70			
	Tappi in nylon per barra quadra Nylon caps for square bar Bouchons en nylon pour barre carrée		BQC00024A	Cp		50
	Tappo copridado Nut cover cap Cache-écrou	mm 13	TAP130005	Pz		50
		mm 17	TAP170001	Pz		50

Disegno Figure Design	Descrizione Description Description	Codice Article Code Code Article	U.M. Unit	Prezzo unitario Unit price Prix unitaire	Conf. std. Std. pack Cf. std
-----------------------------	---	--	--------------	--	------------------------------------

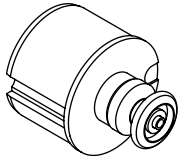

Calotta scorrevole ø 60
Plug sliding ø 60
Embout coulissant ø 60

Zincato TAPSCORZINCA
Inox TAPSCORINOX

Pz

100

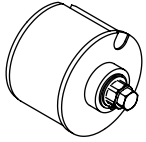

Calotta rompitratta ø 60 (Fisso) con perno
Plug windbreak ø 60 (Fixed) with pin
Embout brise-vent ø 60 (Fixe) avec axe

Zincato TAPFRAZIN60A
Inox TAPFRAINOX60ZA

Pz

100

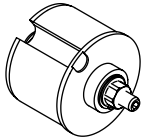

Calotta perno filettato ø 60
Plug threaded pin ø 60
Embout axe fileté ø 60

Zincato TMT000011A
Inox TMT00012A

Pz

100

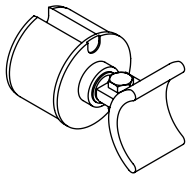

Cravatta perno e tappo ø 60
Per traverse frangivento
Cap and pin dia60 (tie) windbreak
Support axe e embout ø 60 Pour brise-vent

TMT0009A

Pz

50

ASTE DI MANOVRA/ MANEUVER AUCTIONS

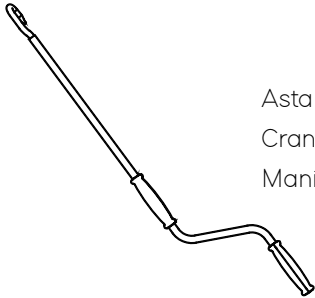

Asta di manovra verniciata
Crank handle
Manivelle

Cm 35 AST0A100
Cm 50 AST0A120
Cm 70 AST0A150
Cm 90 AST0A180
Cm 120 AST0A200
Cm 140 AST0A200
Cm 250 AST0A250
Cm 300 AST0A300

Pz

10

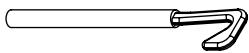

Asta per tm/tnr
Crank handle for tm/tnr
Manivelle pour tm/tnr

TM0D006

Pz

25

TUBI AVVOLGITORI/ROLLER TUBE TUBES ENROULEUR

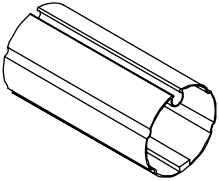
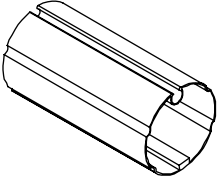
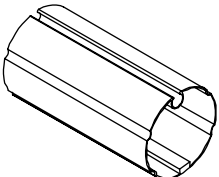
Disegno Figure Dessign	Descrizione Description Description	Codice Article Code Code Article	U.M. Unit Unit	Prezzo unitario Unit price Prix unitaire	Conf. std. Std. pack Cf. std
		Cm 300	AVV30060		
	Tubo avvolgitore ø 60	Cm 400	AVV40060		
	Winder tube ø 60	Cm 500	AVV50060	Pz	10
	Tube enrouleur ø 60	Cm 600	AVV60060		
		Cm 700	AVV70060		
		Cm 400	AVV40070		
	Tubo avvolgitore ø 70	Cm 500	AVV50070	Pz	10
	Winder tube ø 70	Cm 600	AVV60070		
	Tube enrouleur ø 70	Cm 700	AVV70070		
		Cm 400	AVV40078		
	Tubo avvolgitore ø 78	Cm 500	AVV50078	Pz	10
	Winder tube ø 78	Cm 600	AVV60078		
	Tube enrouleur ø 78	Cm 700	AVV70078		

TUBO AVVOLGITORE TENDE IN CRISTAL

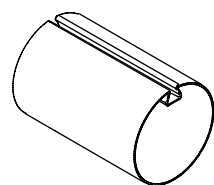



Tubo avvolgitore ø 70 ogiva schiacciata
Rolling tube ø 70 flattened ogive
Tube roulant ø 70 ogive aplatie

Cm 700 AVVOS70070 Pz 10

Disegno Figure Dessign	Descrizione Description Description	Codice Article Code Code Article	U.M. Unit Unit	Prezzo unitario Unit price Prix unitaire	Conf. std. Std. pack Cf. std
------------------------------	---	--	----------------------	--	------------------------------------

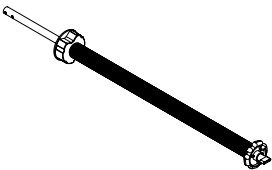
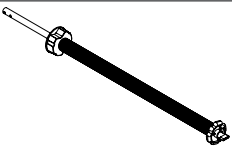
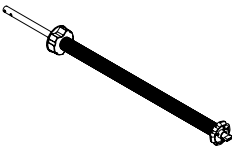
MOLLE COMPLETE

		Cm 35	MOLLA35		
		Cm 50	MOLLA50		
	Molla assemblata ø 60	Cm 70	MOLLA70	Pz	10
	Spring assembled ø 60	Cm 90	MOLLA90		
	Ressort assemblé ø.60	Cm 120	MOLLA120		
		Cm 140	MOLLA140 (Tondino pieno)		
		Cm 70	MOLLA70/70		
	Molla assemblata ø 70 tondino vuoto	Cm 90	MOLLA90/70	Pz	10
	Spring assembled rod empty ø 70	Cm 120	MOLLA120/70		
		Cm 140	MOLLA140/70	Pz	10
	Molla assemblata ø 70 tondino pieno	Cm 180	MOLLA180/70		
		Cm 290	MOLLA-DOP 290	Pz	10
	Doppia molla assemblata ø 70	Cm 360	MOLLA-DOP 360		
	Double spring assemble ø 70				
	Double ressort assemblé ø 70				

MOLLE/SPRINGS/RESSORTS

Disegno Figure Design	Descrizione Description Description	Codice Article Code Code Article	U.M. Unit	Prezzo unitario Unit price Prix unitaire	Conf. std. Std. pack Cf. std
-----------------------------	---	--	--------------	--	------------------------------------

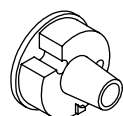

Kit portamolla ø 60
Kit spring holder ø 60
Kit porte rouleaux ø 60
Tappo portamolla ø 60
Caps for spring holder ø 60
Caps for spring holder ø 60
Conetto portamolla ø 60
Cone-holder ø 60
Cone-holder ø 60
Distanziale ø 60
Distance ø 60
Distance ø 60

KIT.0D001

TAPPOPM60

CONETTOPM60

DISTANZIALE60

Pz

100

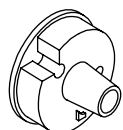

Kit portamolla ø 70
Kit spring holder ø 70
Kit porte rouleaux ø 70
Tappo portamolla ø 70
Caps for spring holder ø 70
Caps for spring holder ø 70
Conetto portamolla ø 70
Cone-holder ø 70
Cone-holder ø 70
Distanziale ø 70
Distance ø 70
Distance ø 70

KIT.0D002

TAPPOPM70

CONETTOPM70

DISTANZIALE70

Pz

100

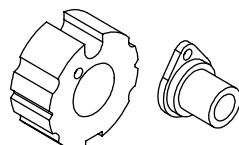

Distanziale e fermo per doppia molla 290/360
Distance and spring retainer double 290/360
Distancier et arret pour double ressort 290/360

MOLLA-DF

Pz

10

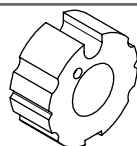

Distanziale per molla 140/180
Distance for spring from 140/180
Distancier pour ressort 140/180

MOLLA-DI

Pz

10

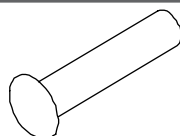

Ribattino per molla
Rivet for spring
Rivet pour ressort

MOLLA-RIB

Pz

1000

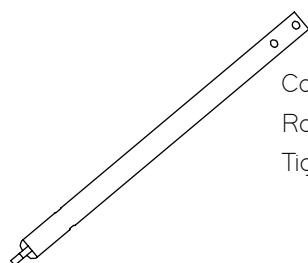

Cannetta
Rod
Tige

Cm 50 CANNA MOLLA 35
Cm 70 CANNA MOLLA 50
Cm 90 CANNA MOLLA 70
Cm 120 CANNA MOLLA 90
Cm 140 CANNA MOLLA 120
Cm 180 CANNA MOLLA 140
Cm 230 CANNA MOLLA 180

Pz

20

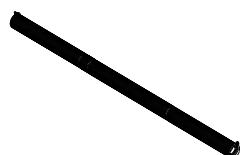

Aspirale
Spring spiral
Spirale

Cm 35 MOLLA ASP 35
Cm 50 MOLLA ASP 50
Cm 70 MOLLA ASP 70
Cm 90 MOLLA ASP 90
Cm 120 MOLLA ASP 120
Cm 140 MOLLA ASP 140
Cm 180 MOLLA ASP 180

Pz

20

BRACCI/ARMS/ARMES

Disegno Figure Dessign	Descrizione Description Description	Codice Article Code Code Article	U.M. Unit	Prezzo unitario Unit price Prix unitable	Conf. std. Std. pack Cf. std
------------------------------	---	--	--------------	--	------------------------------------

BRACCI/ARMS/ARMES Mod. BQC

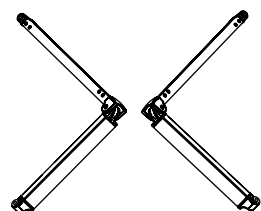

Bracci a catena
Arms with chain
Bras à chaîne

Cm 160	BRA0A160			
Cm 185	BRA0A185			
Cm 210	BRA0A210			
Cm 235	BRA0A235			
Cm 260	BRA0A260	Cp		10
Cm 285	BRA0A285			
Cm 310	BRA0A310			
Cm 360	BRA0A360			
Cm 410	BRA0A440			

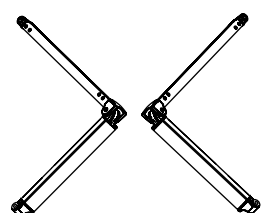

Bracci a cavetto
Arms with cable
Bras à câble

Cm 160	BQCCAV0A160			
Cm 185	BRACAV0A185			
Cm 210	BRACAV0A210			
Cm 235	BRACAV0A235			
Cm 260	BRACAV0A260	Cp		10
Cm 285	BRACAV0A285			
Cm 310	BRACAV0A310			
Cm 360	BRACAV0A360			
Cm 410	BRACAV0A410			

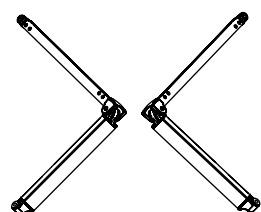

Bracci con cavetti in acciaio Rivestiti
Arms with steel wires Couted
Bras avec câble en acier recouvert

Cm 160	BRA0A160F			
Cm 185	BRA0A185F			
Cm 210	BRA0A210F			
Cm 235	BRA0A235F			
Cm 260	BRA0A260F	Cp		10
Cm 285	BRA0A285F			
Cm 310	BRA0A310F			
Cm 360	BRA0A360F			
Cm 410	BRA0A410F			

BRACCI/ARMS/ARMES Mod. TWISTER

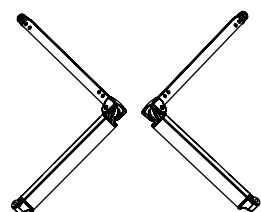

Bracci a catena twister
Arms with chain twister
Bras à chaîne twister

Cm 160	TWS0A160			
Cm 185	TWS0A185			
Cm 210	TWS0A210			
Cm 235	TWS0A235			
Cm 260	TWS0A260	Cp		10
Cm 285	TWS0A285			
Cm 310	TWS0A310			
Cm 360	TWS0A360			
Cm 410	TWS0A410			

BRACCI/ARMS/ARMES Mod. KIRO

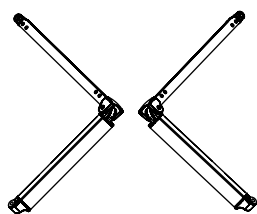

Bracci a catena
Arms with chain
Bras à chaîne

Cm 160	KIR0A160			
Cm 185	KIR0A185			
Cm 210	KIR0A210			
Cm 235	KIR0A235	Cp		10
Cm 260	KIR0A260			
Cm 285	KIR0A285			
Cm 310	KIR0A310			

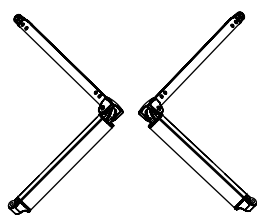

Bracci a cavetto
Arms with cable
Bras à câble

Cm 160	CAV0A160			
Cm 185	CAV0A185			
Cm 210	CAV0A210			
Cm 235	CAV0A235	Cp		10
Cm 260	CAV0A260			
Cm 285	CAV0A285			
Cm 310	CAV0A310			

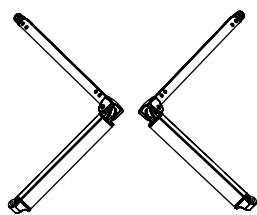

Bracci con cavetti in acciaio Rivestiti
Arms with steel wires Coated
Bras avec câble en acier recouvert

Cm 160	KIR0A-160F			
Cm 185	KIR0A-185F			
Cm 210	KIR0A-210F			
Cm 235	KIR0A-235F	Cp		10
Cm 260	KIR0A-260F			
Cm 285	KIR0A-285F			
Cm 310	KIR0A-310F			

BRACCI/ARMS/ARMES Mod. OMBRA

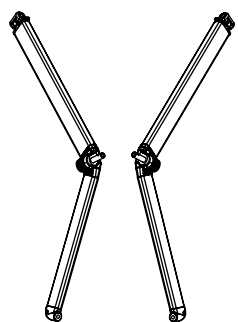

Bracci Ombra 130° A Cavetto
Arms Ombra 130° With Cable
Bras Ombra 130° À Câble

Cm 135	OMBR0A135-130			
Cm 160	OMBR0A160-130			
Cm 185	OMBR0A185-130			
Cm 210	OMBR0A210-130			
Cm 235	OMBR0A235-130	Cp		10
Cm 260	OMBR0A260-130			
Cm 285	OMBR0A285-130			
Cm 310	OMBR0A310-130			

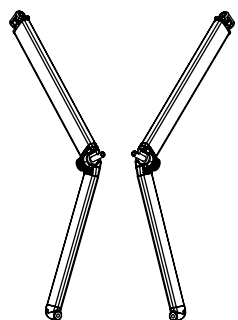

Bracci ombra 170° a cavetto
Arms ombra 170° with cable
Bras ombra 170° à câble

Cm 135	OMBR0A135-170			
Cm 160	OMBR0A160-170			
Cm 185	OMBR0A185-170			
Cm 210	OMBR0A210-170			
Cm 235	OMBR0A235-170	Cp		10
Cm 260	OMBR0A260-170			
Cm 285	OMBR0A285-170			
Cm 310	OMBR0A310-170			

BRACCI/ARMS/ARMES Mod. MILANO

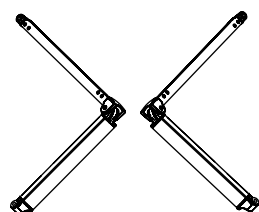

Bracci a catena
Arms with chain
Bras à chaîne

Cm 160	MIL0A160			
Cm 185	MIL0A185			
Cm 210	MIL0A210			
Cm 235	MIL0A235	Cp		10
Cm 260	MIL0A260			
Cm 285	MIL0A285			
Cm 310	MIL0A310			

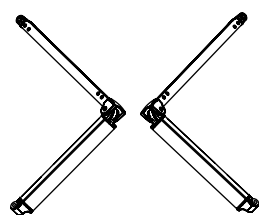

Bracci a cavetto
Arms with cable
Bras à câble

Cm 160	MIL0A160C			
Cm 185	MIL0A185C			
Cm 210	MIL0A210C			
Cm 235	MIL0A235C	Cp		10
Cm 260	MIL0A260C			
Cm 285	MIL0A285C			
Cm 310	MIL0A310C			

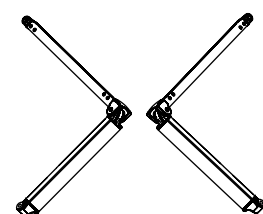

Bracci con cavetti in acciaio Rivestiti
Arms with steel wires Coated
Bras avec câble en acier recouvert

Cm 160	MIL0A160F			
Cm 185	MIL0A185F			
Cm 210	MIL0A210F			
Cm 235	MIL0A235F	Cp		10
Cm 260	MIL0A260F			
Cm 285	MIL0A285F			
Cm 310	MIL0A310F			

BRACCI/ARMS/ARMES Mod. BQC LED

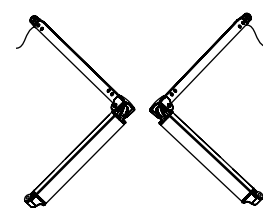

Bracci led BQC a catena
BQC led chain arms
Bras de chaîne à led BQC

Cm 160	BQC-LED-160A			
Cm 185	BQC-LED-185A			
Cm 210	BQC-LED-210A			
Cm 235	BQC-LED-235A			
Cm 260	BQC-LED-260A	Cp		10
Cm 285	BQC-LED-285A			
Cm 310	BQC-LED-310A			
Cm 360	BQC-LED-360A			
Cm 410	BQC-LED-410A			

BRACCI/ARMS/ARMES Mod. KIRO LED

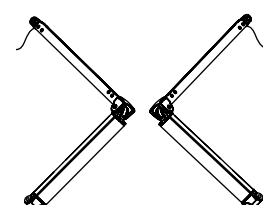

Bracci led KIRO a catena
Led KIRO chain arms
Bras de chaîne LED KIRO

Cm 160	KIRO-LED-160A			
Cm 185	KIRO-LED-185A			
Cm 210	KIRO-LED-210A			
Cm 235	KIRO-LED-235A	Cp		10
Cm 260	KIRO-LED-260A			
Cm 285	KIRO-LED-285A			
Cm 310	KIRO-LED-310A			

BRACCI/ARMS/ARMES Mod. OMBRA LED

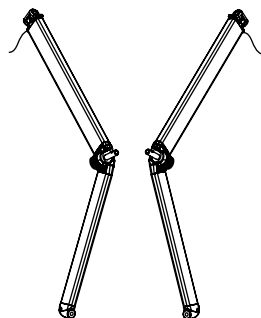

Bracci Ombra 130° A Cavetto
Arms Ombra 130° With Cable
Bras Ombra 130° À Câble

Cm 135	OMBRALED135-130			
Cm 160	OMBRALED160-130			
Cm 185	OMBRALED185-130			
Cm 210	OMBRALED210-130			
Cm 235	OMBRALED235-130	Cp		10
Cm 260	OMBRALED260-130			
Cm 285	OMBRALED285-130			
Cm 310	OMBRALED310-130			
Cm 350	OMBRA0A350-130			

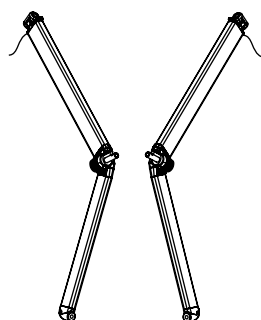

Bracci ombra 170° a cavetto
Arms ombra 170° with cable
Bras ombra 170° à câble

Cm 135	OMBRALED135-170			
Cm 160	OMBRALED160-170			
Cm 185	OMBRALED185-170			
Cm 210	OMBRALED210-170			
Cm 235	OMBRALED235-170	Cp		10
Cm 260	OMBRALED260-170			
Cm 285	OMBRALED285-170			
Cm 310	OMBRALED310-170			
Cm 350	OMBRALED350-170			

MOTORI/MOTORS/MOTEURS

Disegno Figure Dessign	Descrizione Description Description	VA.I.L.A. AUTOMATION	Codice Article Code Code Article	U.M. Unit	Prezzo unitario Unit price (€) Prix unitaire	Conf. std. Std. pack Cf. std
	Motore tubolare ø 45 fine corsa meccanico Tubular motor ø 45 mechanical limit Switch Moteur tubulaire ø 45 fin de course mecanique		VMC 30 VMC 40 VMC 50	Pz		6
	Motore tubolare ø 45 fine corsa meccanico e centrale elettronica integrata, ingressi per anemometro e pulsante Tubular motor ø45 with limit electronic And central electronic integrated Moteur tubulaire ø fin de course mecanique et unite de controle integree, entrees pour anemometre e bouton		VFM 30 VFM 40 VFM 50	Pz		6
	Motore tubolare ø 45 con manovra Di soccorso e fine corsa meccanico Tubular motor ø 45 with override And mechanical limit switch Moteur tubulaire ø 45 avec manoeuvre de secours e fin de course mec.		VCS 30 VCS 40 VCS 50	Pz		6
	Motore tubolare ø 58 Fine corsa meccanico Tubular motor ø 58 With mechanical limit switch Moteur tubulaire ø 58 fin de course mecanique		VMC 80 VMC 100	Pz		6
	Motore tubolare ø 58 con manovra Di soccorso e fine corsa meccanico Tubular motor ø 58 with override And mechanical limit switch Moteur tubulaire ø 58 avec manoeuvre de secours e fin de course mecanique		VCS 80 VCS 100	Pz		6
	Motore tubolare fine corsa elettronico e centrale elettronica integrata Tubular motor ø45 with limit electronic And central electronic integrated Moteur tubulaire fin de course electronique e unite de controle integree		VFE 30 VFE 40 VFE 50 VFE 80	Pz		6

Disegno Figure Design	Descrizione Description Description	Codice Article Code Code Article	U.M. Unit	Prezzo unitario Unit price Prix unitaire	Conf. std. Std. pack Cf. std
	Motore per cappottine Motor for cappottine Moteur pour store corbeille Con comando a pulsante With control button Avec bouton de controle	MEP 40			
	Con ricevente radio integrata e Ingresso per anemometro With radio receiver with integrated And entrance for anemometer Avec recepteur radio integre et entree pour anemometre	MEP 50	Pz		6

E' a disposizione dei Ns. clienti un numero verde che fornisce supporto tecnico sull'installazione dei motoriduttori e centraline elettroniche dalle 8:00 alle 13:00 e dalle 14:00 alle 17:00 dal lunedì al venerdì (gratuito da n° fisso, al costo del proprio operatore da cellulare)

N.B. gli operatori non forniscono supporto commerciale per l'acquisto o la scelta degli stessi, per questo ci si dovrà rivolgere direttamente alla VA.ILA.S.p.A.

Is available for Ns. customers a hotline that provides support technician installing, motors and electronic control units from 8:00 to 13:00 and 14:00 to 17:00 from Monday to Friday (free of No. fixed cost of the operator by phone)

N.B. operators do not provide commercial support for the purchase or the choice of the same, for this you will have to apply directly to VA.ILA.SpA

Il est à la disposition de nos clients une assistance téléphonique qui fournit une assistance technique sur l'installation des moteurs et des unités de contrôle électronique de 8; 00 à 13; 00 et de 14; 00 à 17; 00 du lundi au vendredi (Gratuit à partir du numéro fixe, le coût de l'opérateur de téléphonie mobile).

N.B. les opérateurs ne fournissent pas un support commercial pour l'achat ou le choix de la même, pour cela, vous devrez demander directement à Va.Ila



ELETRONICA E DISPOSITIVI DI COMANDO

ELECTRONICS AND CONTROL DEVICES

ELECTRONIQUE ET DISPOSITIFS DE CONTRÔLE

Disegno Figure Dessign	Descrizione Description Description	Codice Article Code Code Article	U.M. Unit	Prezzo unitario Unit price Prix unitaire	Conf. std. Std. pack Cf. std
	<p>Centralina elettronica con ricevente radio integrata per il controllo mediante radiocomando</p> <p>Electronic radio receiver with integrated Monitoring by remote Control</p> <p>Unité de commande électronique radio avec récepteur intégré pour le contrôle par telecommande</p>	TAG 1	Pz	€	6
	<p>Centralina elettronica con ricevente radio integrata per il controllo mediante radiocomando ingressi: anemometro, pulsante saliscendi e ciclico (passo passo)</p> <p>Electronic radio receiver with integrated Monitoring by remote control inputs: Anemometer, button up and down and Cyclic (step by step)</p> <p>Unité de commande électronique avec récepteur radio intégré pour le contrôle par telecommande entrees: Anemometre, bouton ouver,/ferm.</p>	TAG 4	Pz		6
	<p>Centralina elettronica per il comando singolo e/o simultaneo di due automatismi</p> <p>Electronic for single control and / or Simultaneous two automatic</p> <p>Unité de commande electronique pour le commande unique et/ ousimultanee de deux automatisme.</p>	TAG 3 TAG MINI	Pz		6
	<p>Sensore vento da collegare alla centralina Tag o ai motori vfm</p> <p>Wind sensor to be connected to the unit Tag or vfm</p> <p>Detecteur vent a connecter a l' unite de commande tag ou aux moteurs vfm</p>	WINDY S	Pz		6
	<p>Centralina elettronica con ricevente radio, anemometro e sensore sole tutti integrati in un dispositivo</p> <p>Electronic with radio receiver, air speed Sensor and sun all in an integrated device</p> <p>Unité de commande électronique avec recepteur radio, anemometre et detecteur soleil tous integres dans un dispositif.</p>	WIND SUN	Pz		6
	<p>Centralina elettronica con ricevente Radio, anemometro e sensore pioggia e Sole tutti integrati in un unico dispositivo</p> <p>Electronic with radio receiver, air speed Sensor and rain and sun all in one integrated Device</p> <p>Unité de commande électronique avec recepteur radio, anemometre et detecteur pluie tous integres dans un dispositif.</p>	WIND SUN RAIN	Pz		6

Disegno Figure Design	Descrizione Description Description	Codice Article Code Code Article	U.M. Unit	Prezzo unitario Unit price Prix unitaire	Conf. std. Std. pack Cf. std
	<p>Centralina elettronica sensore wireless vento, sole da abbinare alle centraline elettroniche tag1 e tag4 e a motoriduttori vfm</p> <p>Electronic wireless sensor wind, sun to Combine to electronic and tag1 and tag4 And motors vfm</p> <p>Unité de commande électronique sans fil vent, soleil a onnecter aux unités de commande tag1 et tag4 e moteurs vfm</p>	WIND SUN WII	Pz		6
	<p>Centralina elettronica sensore wireless Vento,sole e pioggia da abbinare alle centraline Elettroniche tag1 e tag4 e ai motoriduttori Vfm</p> <p>Electronic wireless sensor wind, sun and Rain to combine to electronic and tag1 And tag4 and motors vfm</p> <p>Unité de commande électronique sans fil vent, soleil et pluie a onnecter aux unités de commande tag1 et tag4 e moteurs vfm.</p>	WIND SUN RAIN WII	Pz		6
	<p>Centralina elettronica con trasmettitore Radio 433,92 mhz, anemometro e sensore Sole integrati, e compatibile con i motoriduttori Tubolari con fine corsa elettronico Della serie vfe</p> <p>Electronic and a device with radio transmitter 433.92 Mhz, anemometer and sun Sensor integrated, compatible with tubular Motors with electronic switch series Vfe</p> <p>Unité de commande électronique avec radio emetteur 433.92 Mhz, anemometre et detecteur soleil integres, compatible avec moteurs tubulaires avec fin de course electronique serie vfe</p>	WINDY SA	Pz		6
	<p>Centralina elettronica sensore wireless Vento,sole, pioggia e temperatura da abbinare Ai motoriduttori vfe</p> <p>Electronic wireless sensor wind, sun, Rain and temperature to combine to Motors vfe</p> <p>Unite de commande electronique detecteur sans fil vent, pluie et temperature pour moteurs serie vfe.</p>	WINDY SR	Pz		6
	<p>Centralina elettronica con trasmettitore Radio 433,92 mhz, anemometro e sensore Sole integrati, e autoalimentazione con Pannello solare e compatibile con i motoriduttori Tubolari con fine corsa elettronico Della serie vfe</p> <p>Electronic and a device with radio transmitter 433.92 Mhz, anemometer and sun Sensor integrated, self-powered with Solar panel compatible with tubular Motors with electronic switch series vfe</p> <p>Unité de commande électronique avec radio emetteur 433.92 Mhz, anemometre et detecteur soleil integre, auto-alimentation avec panneau solaire et compatible avec moteurs tubulaires vfe.</p>	WINDY SA +	Pz		6

Disegno Figure Dessign	Descrizione Description Description	Codice Article Code Code Article	U.M. Unit	Prezzo unitario Unit price Prix unitaire	Conf. std. Std. pack Cf. std
------------------------------	---	--	--------------	--	------------------------------------



Centralina elettronica sensore wireless vento, sole, pioggia e temperatura e autoalimentazione con pannello solare da abbinare ai motoriduttori vfe

Electronic wireless sensor wind, sun, Rain and temperature self-powered with Solar panel to combine to motors vfe

Unité de commande électronique détecteur sans fil vent, soleil, pluie et température, auto-alimentation avec panneau solaire compatible avec moteurs vfe.

WINDY SR +

Pz

6

Sensore di movimento per la rivelazione Delle oscillazioni della tenda. Si installa Sul terminale e riavvolge la tenda quando Questa e' sottoposta a vibrazioni provocate Dal vento. Un sensore per tenda.

Motion sensor for the detection of oscillations Of the awning. It is installed on the Terminal profiles and winds up the awning When it is subjected to vibrations caused by The wind. One sensor for each awning.

Capteur de mouvement pour la détection Les oscillations de la tente. Il est installé Sur le terminal et rembobiner la tente quand Ceci est soumis aux vibrations provoquées Du vent. Un capteur de rideau.





3D EVO

Pz

6

TELECOMANDI REMOTE CONTROLS TÉLÉCOMMANDES

Disegno Figure Dessign	Descrizione Description Description	Codice Article Code Code Article	U.M. Unit	Prezzo unitario Unit price Prix unitaire	Conf. std. Std. pack Cf. std
	<p>Radiocomando ad 1 canale per il controllo Di un automatismo</p> <p>Radio control 1 channel for control of An automatic</p> <p>Telecommande a 1 chaine pour le controle d'un automatisme.</p>	WHITE 1	Pz	€	6
	<p>Radiocomando a 3 canali per il controllo singolo e/o simultaneo di 3 automatismi, con funzione di abilitazione o disabilitazione del sensore sole delle centraline windsun e windsunrain</p> <p>Radio control 3 channels for control Single and / or simultaneous 3 automatismi, With function enable or disable sensor Sun unit of sun and wind wind sun rain</p> <p>Telecommande a 3 chaines pour le controle unique et/ou simultanee de 3 automatismes, avec la fonction de activation ou désactivation du detecteur soleil des unites de controle windsun/windsunrain.</p>	WHITE 3	Pz	€	6
	<p>Radiocomando a 6 canali per il controllo singolo e/o simultaneo di 6 automatismi, con funzione di abilitazione o disabilitazione del sensore del sole delle centraline windsun e windsunrain</p> <p>Radio control 6 channels for control Single and / or simultaneous 6 automatismi, With function enable or disable sensor Sun unit of sun and wind wind sun rain</p> <p>Telecommande a 6 chaines pour le controle unique et/ou simultanee de 6 automatismes, avec la fonction de activation ou désactivation du detecteur soleil des unites de controle windsun/windsunrain.</p>	WHITE 6	Pz	€	6

Disegno Figure Dessign	Descrizione Description Description	Codice Article Code Code Article	U.M. Unit	Prezzo unitario Unit price Prix unitaire	Conf. std. Std. pack Cf. std
------------------------------	---	--	--------------	--	------------------------------------



Radiocomando a 1 canale clarus1 a frequenza 433,92 Mhz controllata mediante risuonatore Saw con un'innovativa codifica variabile. Questa codifica offre oltre 18 miliardi di Combinazioni, garantendo così sicurezza ed Assenza di azionamenti indesiderati

Radio control 1 channel clarus 1 radio Frequency 433.92 Mhz controlled saw Resonator innovated coding with a variable. This code provides more than 18 billion Combinations so ensuring safety purpose And non-drive side.

CLARUS 1

Pz

6

Telecommande 1 chaine clarus1 fréquence 433,92 mhz contrôlé par résonateur saw avec un innovant code variable. Ce code fournit plus de 18 milliards de combinaison, en assurant ainsi la sécurité et absence d'activation indesideres.



Radiocomando a 6 canali clarus 6 a frequenza 433,92 mhz controllata mediante risuonatore saw con un'innovativa codifica variabile. Questa codifica offre oltre 18 miliardi di combinazioni, garantendo così sicurezza ed assenza di azionamenti indesiderati

Radio control 6 channel clarus 6 radio Frequency 433.92 Mhz controlled saw Resonator innovated coding with a variable. This code provides more than 18 billion Combinations so ensuring safety purpose And non-drive side.

CLARUS 6

Pz

6

Telecommande 6 chaines clarus6 fréquence 433,92 mhz contrôlé par résonateur saw avec un innovant code variable. Ce code fournit plus de 18 milliards de combinaison, en assurant ainsi la sécurité et absence d'activation indesideres.



Radiocomando da parete con frequenza 433.92 Mhz in grado di gestire un gruppo di Automazioni. Compatibile con motori serie Vmc, vcs e vfm. Disponibile in 3 colori: bianco Lucido, argento metallizzato e nero Opaco.

Wall radio control with frequency 433,92 Mhz able to manage a group of automations. Compatible with engines series vmc, Vcs e vfm. Available in 3 coloros: glossy White, metallic silver and opaque black.

CUADRO

Pz

6

Telecommande mural avec fréquence 433,92 mhz capable de gerer un groupe de automations. Compatible avec moteurs série vmc, vcs et vfm. Disponible en 3 couleurs: blanc brillant, argent metallic et noir matt.



Via Campo Gilliaro 34 00030 San Cesareo (Roma)
 Tel. 06-9559571 Fax 06-9589363 06-9588559
 e.mail: ordini@vailatende.it
 sito: www.vailatende.it

MODULO ORDINE PER ACCESSORI
ORDER MODULE FOR ACCESSORIES
BON DE COMMANDE ACCESSOIRES

IL PRESENTE MODULO NON DEVE ESSERE MODIFICATO IN NESSUNA DELLE SUE PARTI
 THIS MODULE MUST NOT BE MODIFIED IN ANY OF ITS PARTS
 CE FORMULAIRE NE DOIT PAS ETRE MODIFIE EN AUCUN DE SES PARTS

Denominazione cliente
 Customer name
 Nom du client

Data ordine

CODICE / CODE	DESCRIZIONE / DESCRIPTION	U.M.	QUANTI- TA QUAN- TITY	COLORE COLOR	ALLUMINIO ALLUMINIUM	NYLON	PR

NOTE-ANNOTATION-NOTES

**N.B. EVENTUALI DATE DI CONSEGNA RICHIESTE NON VINCOLANO IN ALCUN MODO LA DITTA VA.ILA. A RISPETTARE LE STESSE;
 E' INTERESSE DEL CLIENTE ACCERTARSI TELEFONICAMENTE SE POSSIBILE RICEVERE IL MATERIALE ENTRO LA DATA RICHIESTA.
 N.B. EVENTUALLY REQUESTED DELIVERY DATES DO NOT ALLOW THE COMPANY VA.ILA IN ANY WAY. TO RESPECT THE SAME;
 IT IS CUSTOMER'S INTEREST TO MAKE SURE THAT THE MATERIAL CAN BE RECEIVED BY THE REQUEST DATE.
 N.B. LES DATES DE LIVRAISON EVENTUELLEMENT DEMANDEES NE PERMETTENT PAS LA SOCIETE VA.ILA DE TOUTE MANIERE. RESPECTER LA MÊME CHOSE;
 C'EST L'INTÉRÊT DU CLIENT DE S'ASSURER QUE LE MATÉRIEL PEUT ÊTRE REÇU À LA DATE DE LA DEMANDE.**



VA.ILA. S.p.A.

Via Campo Gillaro, 34

00030 San Cesareo (Roma)

Tel. 06.95.59.571 - Fax 06.95.89.363 06.95.88.559

e.mail: vaila@vailatende.it - ordini@vailatende.it - preventivi@vailatende.it

sito: www.vailatende.it

